

HAMEG

Instruments

MANUAL

Oscilloscope HM203-6

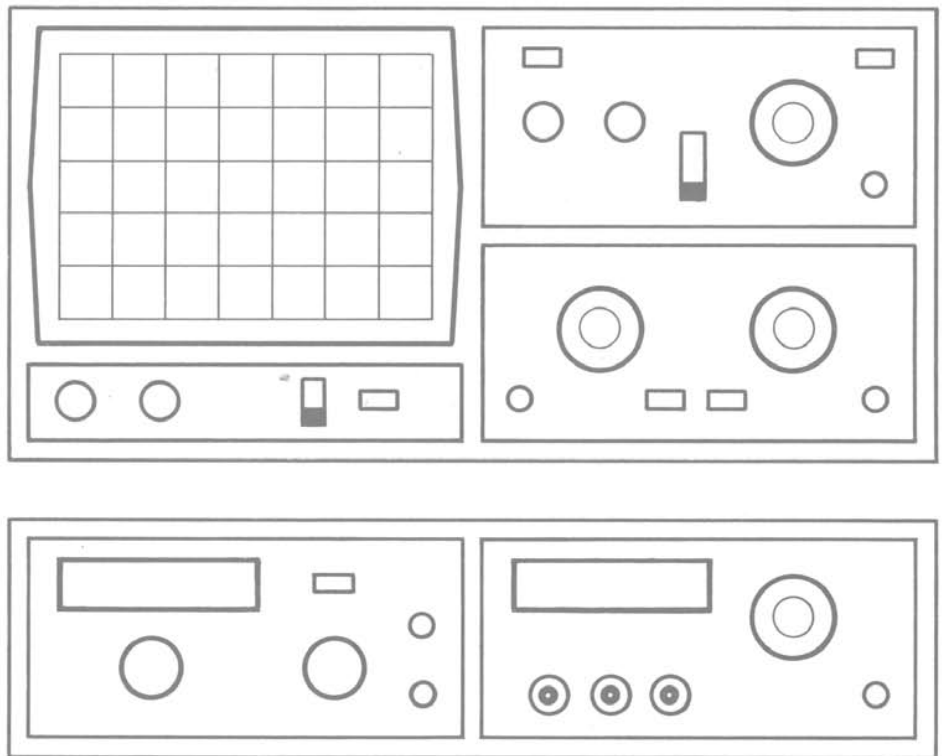

**Oscilloscope datasheet
with technical details** P 1

Accessories Z 1

Operating Instructions

General Information M 1
 Use of tilt handle M 1
 Safety M 1
 Operating conditions M 2
 Guarantee M 2
 Maintenance M 2
 Switching over the mains/line voltage M 2
 Type of the signal voltage M 3
 Amplitude Measurement M 3
 Time Measurements M 4
 Connection of Test Signal M 6
 First Time Operation M 7
 Trace Rotation M 8
 DC Balance Adjustment M 8
 Probe compensation and use M 8
 1 kHz compensation M 8
 1 MHz compensation M 8
 Operating modes of the vertical amplifiers M 9
 X-Y Operation M 9
 Phase difference measurement in DUAL mode M10
 Measurement of an amplitude modulation M10
 Triggering and time base M11
 Automatic Triggering M11
 Normal Triggering, Slope M11
 Trigger coupling M12
 Line Triggering M12
 Triggering of video signals M12
 External triggering, Trigger indicator M13
 Holdoff-time adjustment M13
 Component Tester M14
 Test patterns M17

Short instruction K 1

Front panel elements
 Folder with front view K 2

Test Instructions

General T 1
 Cathode-Ray Tube: Brightness and Focus,
 Linearity, Raster Distortions T 1
 Astigmatism Check T 1
 Symmetry and Drift of the Vertical Amplifier T 1
 Calibration of the Vertical Amplifier T 2
 Transmission Performance (Vertical Amplifier) T 2
 Operating Modes: CH I/II, DUAL, ADD, CHOP,
 INVERT and X-Y Operation T 2
 Triggering Checks T 3
 Timebase T 3
 Holdoff time T 4
 Component Tester T 4
 Trace Alignment T 4
 Mains/Line Voltage Checks T 4

Oscilloscope HM 203-6

Service Instructions

General S 1
 Instrument Case Removal S 1
 Operating Voltages S 1
 Maximum and Minimum Brightness S 1
 Astigmatism control S 2
 Trigger Threshold S 2
 Trouble-Shooting the Instrument S 2
 Replacement of Components and Parts S 2
 Replacement of the Power Transformer S 3
 Adjustments S 3

Circuit Diagrams

Wiring Diagram D 1
 Identification of electrical components D 2
 Y-Inputs, Attenuators,
 Preamplifier Channel I and Channel II,
 Component Locations EY Board D 3
 Y Intermediate Amplifier Channel I and Channel II
 Channel Selection, Calibrator D 4
 Component Locations XY Board D 5
 Trigger Circuit, TV Sync Separator D 6
 Component Locations TB Board D 7
 Timebase Circuit,
 Component Locations IF Board D 8
 Y and X Final Amplifier D 9
 CRT Circuit, Unblanking D10
 Power Supply D11

Specification

Operating Modes

Channel I, Channel II, Channel I and II **alternate** or **chopped** (chop. freq. ≈ 0.5 MHz). **sum** and **difference**: \pm Channel I \pm Channel II (with invert buttons for both channels). **X-Y Mode**: via Channel II and Channel I.

Vertical Deflection (Y)

Bandwidth: 2x DC to 20 MHz (-3 dB).
Risettime: ≈ 17.5 ns. Overshoot: $\leq 1\%$.
Deflection coefficients: 12 calibrated steps from 5 mV/div to 20 V/div in 1-2-5 sequence, variable 1:2.5 to min. **2 mV/div**.
Accuracy in calibrated position: $\pm 3\%$.
Input impedance: 1 M Ω || 30 pF.
Input coupling: AC (-3 dB \triangleq max. 2 Hz) – DC – GROUND.
Input voltage: max. 400 V (DC + peak AC).

Timebase (T)

Time coefficients: 18 calibrated steps from 0.5 μ s/div to 0.2 s/div in 1-2-5 sequence, variable 1:2.5 to min. 0.2 μ s/div, with **X-Magnifier x 10** ($\pm 5\%$) to ≈ 20 ns/div. Accuracy in calibrated position: $\pm 3\%$. Hold-off-time: variable control $\approx 10:1$.
Trigger system: Automatic (≥ 10 Hz) or Normal with level control. **LED indication** for trig. action. Bandwidth: **DC to 40 MHz** ≥ 0.5 div, ext. ≥ 0.25 V. Slope: positive or negative. Sources: Ch. I, Ch. II, line, external. Coupling: **AC** (≥ 10 Hz), **DC, LF** (DC to ≤ 1 kHz), **HF** (≥ 1.5 kHz to 40 MHz).
Active TV-Sync-Separator for line and frame.

Horizontal Deflection (X)

Bandwidth: DC to 2.5 MHz (-3 dB).
Input via Ch. II (see Vertical Deflection spec.).
X-Y phase shift: $< 3^\circ$ up to **120 kHz**.

Component Tester

Test voltage: max. 8.5 V_{rms} (open circuit).
Test current: max. 24 mA_{rms} (shorted).
Test frequency: 50 - 60 Hz (line frequency).
Test connection: 2 banana jacks 4 mm \varnothing .
One test lead is grounded (Safety Earth).

General Information

Cathode-ray tube: D14-364 P43/123, **8x10 cm**, rectangular screen, internal graticule, quick heating, **complete Mu-metal shielding**. Acceleration voltage: 2000 V.
Trace rotation: adjustable on front panel.
Calibrator: square-wave generator ≈ 1 kHz for probe compensation. Output: 0.2 V + 2 V $\pm 1\%$.
Line voltages: 110, 125, 220, 240 V \sim . Permissible line fluctuation: $\pm 10\%$. Line frequency range: **50 to 60 Hz**. Power consumption: approx. **40 Watt**.
Protective system: Safety Class I (IEC 348). Weight: approx. 7.5 kg. Color: techno-brown. Cabinet (mm): **W 285, H 145, D 380**. Lockable tilt handle.
Subject to change without notice.
Printed in West Germany 7/86

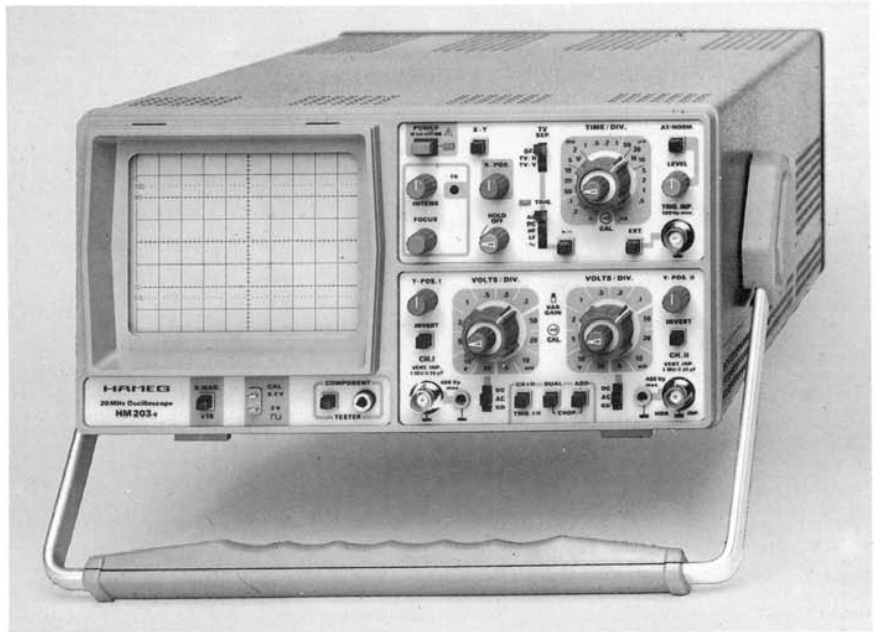

20 MHz Standard Oscilloscope

Y: 2 channels, DC-20 MHz, max. sensitivity 2 mV/div;
X: 0.2 s-20 ns/div incl. x 10 magnification. Component Tester.
Triggering DC up to 40 MHz; active TV-Sync-Separator.

The **HM 203** series is **Western Europe's best selling oscilloscope**. Both vertical amplifiers incorporate **variable gain controls** and maximum input sensitivity is **2 mV/div** over the full bandwidth of the oscilloscope. A further feature permits display of the **sum and difference** of two signals.

Triggering facilities have also been extended. In addition to **line** and **TV** triggering, **HF** and **DC triggering** is possible. The HM 203-6 will **trigger** reliably with a 0.5 div display height up to at least **40 MHz**. Using the manual level control combined with the variable hold-off control, even relatively complex signals can be stably triggered. The time resolution has now been increased to max. **20 ns/div**, including **x10 magnification**.

An 8x10 cm **internal graticule** permits **parallax-free viewing** over a wide angle. The effect of the earth's magnetic field upon horizontal trace position can be compensated for, externally, with a **trace rotation** control.

The **HM 203-6** has a built-in **Component Tester**, which is particularly useful in maintenance and service work. Among other applications, this device enables rapid **in-circuit testing** of semiconductors. Test voltage and current are rated so that normal semiconductors or other components cannot be damaged. **Test results are displayed on the scope screen**.

The **HM 203-6** was designed for **general purpose applications** in industry and service. Its many operating modes, front panel layout, and **ease of operation** also make it an ideal oscilloscope for training engineers and technicians.

Accessories optional

Probes: 1X, 10X, 10X(HF), 100X, 1X/10X (switchable); demodulating probe; test cables BNC-BNC and banana-BNC; 50 Ω BNC feed-through termination; viewing hood; carrying case; etc.

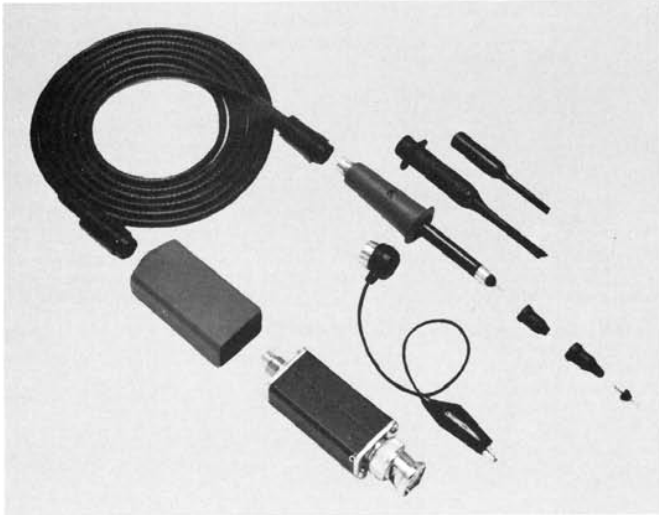

Modular Probes

The clear advantage over ordinary probes are field replaceable parts and the HF-compensation feature on the 10:1 attenuator probes. For the first time, probes in this price range allow adjustments of their HF-characteristics to match individually the input impedance of each scope. This is particularly important for scopes with higher bandwidths (>50MHz), as otherwise strong overshoot or rounding may occur, when measuring fast-rising square waves. An exact HF-compensation, however, is only possible with square-wave generators having a risetime <5ns. Most HAMEG scopes already feature such a calibration generator. For other oscilloscopes, it is available as accessory item HZ60. At present the following Modular Probes are available:

Type	HZ50	HZ51	HZ52	HZ53	HZ54 selectable
Attenuation Ratio	1:1	10:1	10:1 (HF)	100:1	1:1 / 10:1
Bandwidth min. (MHz)	30	150	250	150	10 / 150
Risetime (ns)	11	<2	<1.4	<2	35 / <2
Inp. Capacitance (pF)	45	16	16	6,5	40/18
Inp. Resistance (MΩ)	1	10	10	100	1/10
Inp. Voltage max. (V _p)	600	600	600	1200	600
Cable Length (m)	1.2	1.2	1.5	1.5	1.2

Demodulator Probe

HZ55

Special probe for AM-demodulation and wobulator measurements. HF-Bandwidth 100kHz - 500MHz (±1dB). AC Input Voltage 250mV - 50V_{rms}. DC Isolation Voltage 200V DC including peak AC. Cable length 1.2m.

Conventional Probes

These popular standard probes are well suited for all oscilloscopes up to 20MHz bandwidth (HZ37 only with HF adjustment facility).

Typ	HZ30	HZ35	HZ36 selectable	HZ37 selectable	HZ39 selectable
Attenuation Ratio	10:1	1:1	1:1 / 10:1	1:1 / 10:1	1000:1
Bandwidth min. (MHz)	100	10	10 / 100	10 / 150	1
Risetime (ns)	3.5	35	35 / 3.5	20 / 3.2	50
Inp. Capacitance (pF)	13	47	47/13	44/13	3
Inp. Resistance (MΩ)	10	1	1/10	1/10	500
Outp. Resistance (MΩ)	1	1	1	1	1/10
Inp. Voltage (max. V _p)	600	600	600	600	15000
Cable Length (m)	1.5	1.5	1.5	1.2	1.5

Test Cable Banana—BNC

HZ32

Coaxial test cable; length 1.15 m, characteristic impedance 50Ω. Cable capacitance 120pF. Input voltage max. 500V_p.

Test Cable BNC—BNC

HZ34

Coaxial test cable; length 1.2m, characteristic impedance 50Ω. Cable capacitance 126pF. Input voltage max. 500V_p.

Adapter Banana—BNC

HZ20

Two 4mm binding posts (19mm between centers) to standard BNC male plug. Input voltage max. 500V_p.

50Ω Through-Termination

HZ22

For terminating systems with 50Ω characteristic impedance. Maximum load 2W. Max. voltage 10V_{rms}.

Carrying Cases

For HM203-1 and HM203-3	HZ42
For HM312, HM412, HM512 and HM705	HZ43
For HM307, HZ62 and HZ64	HZ44
For HM103	HZ45
For HM203-4, HM203-5, HM203-6, HM204, HM204-2, HM205, HM208 and HM605	HZ46

Viewing Hood

HZ47

For HM203, HM204, HM205, HM208, HM605, HM705, HM808 and HM312, HM412, HM512, HM812

Scope-Tester

HZ60

For Checking the Y amplifier, timebase, and compensation of all probes, the HZ60 is a crystal-controlled, fast rising (typ. 3 ns) square-wave generator with switchable frequencies of 1, 10, 100 kHz, and 1 MHz. Three BNC outputs provide signals of 25mV_{pp} into 50Ω, 0.25V_{pp} and 2.5V_{pp} (open circuit for 10x and 100x probes); accuracy ±1%. Battery-powered or AC supply operated (optional).

Component-Tester

HZ65

Indispensable for trouble-shooting in electronic circuits. Single component and in-circuit tests are both possible. The HZ65 operates with all scopes, which can be switched to X-Y operation (ext. horizontal deflection). Non-destructive tests can be carried out on almost all semiconductors, resistors, capacitors, and coils. Two sockets provide for quick testing of the 3 junction areas in any small power transistor. Other components are connected by using 2 banana jacks. Test leads supplied.

Examples of Test Displays:

Short circuit Capacitor 33μF Junction E-C Z-Diode <8V



Operating Instructions

General Information

This oscilloscope is easy to operate. The logical arrangement of the controls allows anyone to become familiar with the operation of the instrument after a short time, however, experienced users are also advised to read through these instructions so that all functions are understood.

Immediately after unpacking, the instrument should be checked for mechanical damage and loose parts in the interior. If there is transport damage, the supplier must be informed immediately. The instrument must then not be put into operation.

Check that the instrument is set to the correct mains/line voltage. If not, refer to instructions on page M2.

Use of tilt handle

To view the screen from the best angle, there are three different positions (C, D, E) for setting up the instrument. If the instrument is set down on the floor after being carried, the handle remains automatically in the upright carrying position (A).

In order to place the instrument onto a horizontal surface, the handle should be turned to the upper side of the oscilloscope (C). For the D position (10° inclination), the handle should be turned in the opposite direction out of the carrying position until it locks in place automatically underneath the instrument. For the E position (20° inclination), the handle should be pulled to release it from the D position and swing backwards until it locks once more.

The handle may also be set to a position for horizontal carrying by turning it to the upper side to lock in the B position. At the same time, the instrument must be moved upwards, because otherwise the handle will jump back.

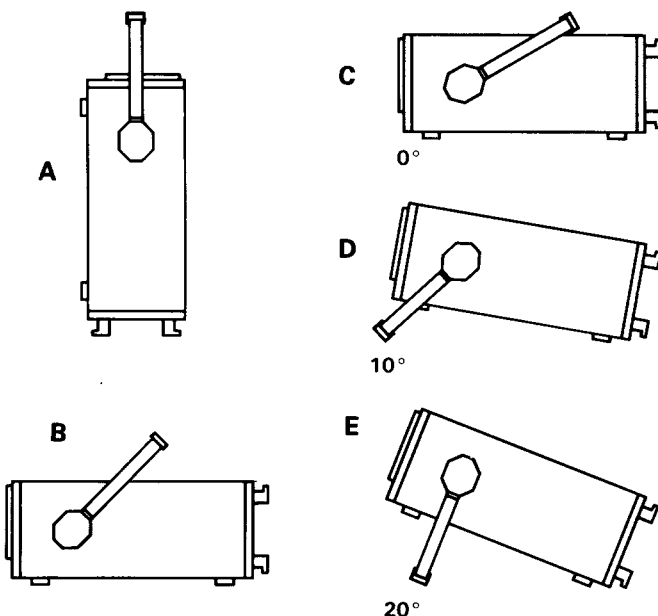

Safety

This instrument has been designed and tested in accordance with **IEC Publication 348, Safety Requirements for Electronic Measuring Apparatus**, and has left the factory in a safe condition. The present instruction manual contains important information and warnings which have to be followed by the user to ensure safe operation and to retain the oscilloscope in safe condition. The case, chassis and all measuring terminals are connected to the protective earth contact of the appliance inlet. The instrument operates according to **Safety Class I** (three-conductor power cord with protective earthing conductor and a plug with earthing contact). The mains/line plug shall only be inserted in a socket outlet provided with a protective earth contact. The protective action must not be negated by the use of an extension cord without a protective conductor.

Warning! Any interruption of the protective conductor inside or outside the instrument or disconnection of the protective earth terminal is likely to make the instrument dangerous. Intentional interruption of the protective earth connection is prohibited. The mains/line plug should be inserted before connections are made to measuring circuits.

The grounded accessible metal parts (case, sockets, jacks) and the mains/line supply contacts (line, neutral) of the instrument have been tested against insulation breakdown with **2000 V r.m.s. (50 Hz)**.

Under certain conditions, 50 Hz or 60 Hz hum voltages can occur in the measuring circuit due to the interconnection with other mains/line powered equipment or instruments. This can be avoided by using an isolation transformer (Safety Class II) between the mains/line outlet and the power plug of the instrument. When displaying waveforms where the "low-level" side of the signal is at a high potential, even with the use of a protective isolation transformer, it should be noted that this potential is connected to the oscilloscope's case and other accessible metal parts. High voltages are dangerous. In this case, special safety precautions are to be taken, which must be supervised by qualified personnel if the voltage is higher than 42 V.

Most cathode-ray tubes develop X-rays. However, **the dose equivalent rate falls far below the maximum permissible value of 36 pA/kg (0.5 mR/h)**.

Whenever it is likely that protection has been impaired, the instrument shall be made inoperative and be secured against any unintended operation. The protection is likely to be impaired if, for example, the instrument

- shows visible damage,
- fails to perform the intended measurements,
- has been subjected to prolonged storage under unfavourable conditions (e.g. in the open or in moist environments),
- has been subject to severe transport stress (e.g. in poor packaging).

Operating conditions

The instrument has been designed for indoor use. The permissible ambient temperature range during operation is +10°C ... +40°C. It may occasionally be subjected to temperatures between +10°C and -10°C without degrading its safety. The permissible ambient temperature range for storage or transportation is -40°C ... +70°C.

The maximum operating altitude is up to 2200m (non-operating 15000m). The maximum relative humidity is up to 80%.

If condensed water exists in the instrument it should be acclimatized before switching on. In some cases (e.g. extremely cold oscilloscope) two hours should be allowed before the instrument is put into operation. The instrument should be kept in a clean and dry room and must not be operated in explosive, corrosive, dusty, or moist environments. The oscilloscope can be operated in any position, but the convection cooling must not be impaired. **The ventilation holes may not be covered.** For continuous operation the instrument should be used in the horizontal position, preferably tilted upwards, resting on the tilt handle.

The specifications stating tolerances are only valid if the instrument has warmed up for 30 minutes at an ambient temperature between +15°C and +30°C. Values not stating tolerances are typical for an average instrument.

Guarantee

Each instrument runs through a quality test with 10 hour burn-in before leaving the production. Practically every early failure is detected in intermittent operation by this method. However, it is possible that a component fails only after a lengthy operating period. Therefore a **functional guarantee of 2 years** is given for all units. The condition for this is that no modifications have been made in the instrument. In the case of shipments by post, rail or carrier it is recommended that the original packing is carefully preserved. Transport damages and damage due to gross negligence are not covered by the guarantee.

In the case of a complaint, a label should be attached to the housing of the instrument which describes briefly the faults observed. If at the same time the name and telephone number (dialing code and telephone or direct number or department designation) is stated for possible queries, this helps towards speeding up the processing of guarantee claims.

Maintenance

Various important properties of the oscilloscope should be carefully checked at certain intervals. Only in this way is it largely certain that all signals are displayed with the accuracy on which the technical data are based. The test methods described in the test plan of this manual can be performed without great expenditure on measuring instruments. However, purchase of the new HAMEG scope tester HZ 60, which despite its low price is highly suitable for tasks of this type, is very much recommended.

The exterior of the oscilloscope should be cleaned regularly with a dusting brush. Dirt which is difficult to remove on the casing and handle, the plastic and aluminium parts, can be removed with a moistened cloth (99% water + 1% mild detergent). Spirit or washing benzine (petroleum ether) can be used to remove greasy dirt. The screen may be cleaned with water or washing benzine (but not with spirit (alcohol) or solvents), it must then be wiped with a dry clean lint-free cloth. Under no circumstances may the cleaning fluid get into the instrument. The use of other cleaning agents can attack the plastic and paint surfaces.

Switching over the mains/line voltage

The instrument is set for 220 V line voltage on delivery. It can be switched over to other voltages at the fuse holder combined with the 3-pole appliance inlet at the rear of the instrument. Firstly the fuse holder printed with the voltage values is removed using a small screw driver and - if required - provided with another fuse. Refer to the table below for the prescribed value of the fuse. Then replace the fuse holder so that the impressed white triangle points to the desired voltage. Here pay attention that the cover plate is also correctly engaged. The use of repaired fuses or short circuiting the fuse holder is not allowed. Damage arising because of this is not covered by the guarantee.

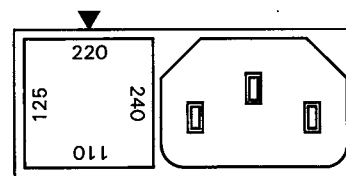

Fuse type: Size **5 x 20 mm**; 250 V~, C; IEC 127, Sheet III; DIN 41 662 (possibly DIN 41 571 sheet 3).

Cutoff: **time lag (T)**.

Line voltage	Fuse rating
110 V ~ ±10 %	T0.63 A
125 V ~ ±10 %	T0.63 A
220 V ~ ±10 %	T0.315 A
240 V ~ ±10 %	T0.315 A

Type of the signal voltage

With the HM 203-6, practically all periodically repeating signals with the frequency spectrum below 20 MHz can be examined. The display of simple electrical processes, such as sinusoidal RF and LF signals or line frequency hum voltages is straightforward. When recording square-wave or pulse-type signal voltages, it must be noted that their **harmonics** must also be transmitted. The repetition frequency of the signal must therefore be significantly smaller than the upper limit frequency of the vertical amplifier. Accurate evaluation of such signals is only possible up to approximately 2 MHz repetition frequency.

Displaying composite signals can be difficult, especially if they contain no repetitive higher amplitude content which can be used for triggering. This is the case with bursts, for instance. To obtain a well-triggered display in this case, the assistance of the variable holdoff and/or variable time control may be required.

Television video signals are relatively easy to trigger using the built-in **TV-Sync-Separator** with correct trigger slope setting.

For optional operation as a DC or AC voltage amplifier, the vertical amplifier input is provided with a **DC/AC** switch. The **DC** position should only be used with a series-connected attenuator probe or at very low frequencies or if the measurement of the DC voltage content of the signal is absolutely necessary.

When displaying very low frequency pulses, the flat tops may be sloping with **AC** coupling of the vertical amplifier (**AC** limit frequency approx. 1.6 Hz for -3dB). In this case, **DC** operation is preferred, provided the signal voltage is not superimposed on a too high DC level. Otherwise a capacitor of adequate capacitance must be connected to the input of the vertical amplifier with DC coupling. This capacitor must have a sufficiently high breakdown voltage rating. **DC** coupling is also recommended for the display of logic and pulse signals, especially if the pulse duty factor changes constantly. Otherwise the display will move upwards or downwards at each change. Pure direct voltages can only be measured with **DC**-coupling.

Amplitude Measurements

In general electrical engineering, alternating voltage data normally refers to effective values (rms = root-mean-square value). However, for signal magnitudes and voltage designations in oscilloscope measurements, the peak-to-peak voltage (V_{pp}) value is applied. The latter corresponds to the real potential difference between the most positive and most negative points of a signal waveform.

If a sinusoidal waveform, displayed on the oscilloscope screen, is to be converted into an effective (rms) value, the resulting peak-to-peak value must be divided by $2 \times \sqrt{2} = 2.83$. Conversely, it should be observed that sinusoidal voltages indicated in V_{rms} (V_{eff}) have 2.83 times the potential difference in V_{pp} . The relationship between the different voltage magnitudes can be seen from the following figure.

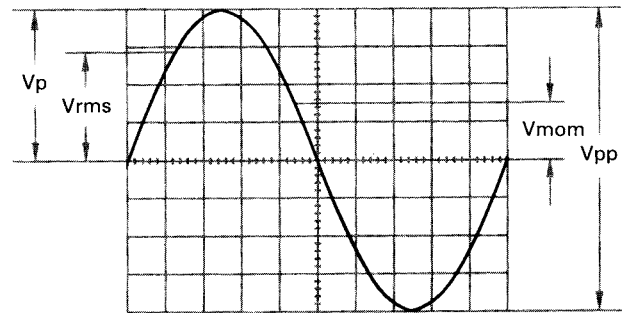

Voltage values of a sine curve

V_{rms} = effective value; V_p = simple peak or crest value;
 V_{pp} = peak-to-peak value; V_{mom} = momentary value.

The minimum signal voltage required at the vertical amplifier input for a display of 1 cm is approximately 2mV_{pp} . This is achieved with the attenuator control set at 5mV/cm , its **variable control in the fully clockwise position**. However, smaller signals than this may also be displayed. The **deflection coefficients** on the input attenuators are indicated in mV/cm or V/cm (peak-to-peak value).

The magnitude of the applied voltage is ascertained by multiplying the selected deflection coefficient by the vertical display height in cm.

If an attenuator probe x 10 is used, a further multiplication by a factor of 10 is required to ascertain the correct voltage value.

For exact amplitude measurements, the variable control on the attenuator switch must be set to its calibrated detent CAL. When turning the variable control cw, the sensitivity will be increased by a factor of 2.5.

Therefore every intermediate value is possible within the 1-2-5 sequence.

With direct connection to the vertical input, **signals up to 160V_{pp}** may be displayed (attenuator set to 20V/cm , variable control ccw).

With the designations

H = display height in cm,

U = signal voltage in V_{pp} at the vertical input,

D = deflection coefficient in V/cm at attenuator switch, the required quantity can be calculated from the two given quantities:

$$U = D \cdot H$$

$$H = \frac{U}{D}$$

$$D = \frac{U}{H}$$

However, these three values are not freely selectable. They have to be within the following limits (trigger threshold, accuracy of reading):

- H** between 0.5 and 8 cm, if possible 3.2 to 8 cm,
- U** between $2.5 V_{pp}$ and $160 V_{pp}$,
- D** between 5 mV/cm and 20 V/cm in 1-2-5 sequence.

Examples:

Set deflection coefficient **D** = 50 mV/cm \cong 0.05 V/cm, observed display height **H** = 4.6 cm, **required voltage U** = $0.05 \cdot 4.6 = 0.23 V_{pp}$.

Input voltage **U** = $5 V_{pp}$, set deflection coefficient **D** = 1 V/cm, **required display height H** = $5:1 = 5 \text{ cm}$

Signal voltage $U = 220 V_{rms} \cdot 2 \cdot \sqrt{2} = 622 V_{pp}$ (voltage > $160 V_{pp}$, with probe x10: **U** = $62.2 V_{pp}$), desired display height **H** = min. 3.2 cm, max. 8 cm, max. deflection coefficient $D = 62.2:3.2 = 19.4 \text{ V/cm}$, min. deflection coefficient $D = 62.2:8 = 7.8 \text{ V/cm}$, **adjusted deflection coefficient D** = **10 V/cm**

If the applied signal is superimposed on a DC (direct voltage) level the total value (DC + peak value of the alternating voltage) of the signal across the Y-input must not exceed $\pm 400 \text{ V}$ (see figure). This same limit applies to normal x10 attenuator probes, the attenuation ratio of which allows signal voltages up to approximately $1,000 V_{pp}$ to be evaluated. Voltages of up to approximately $2,400 V_{pp}$ may be measured by using the HZ53 high voltage probe which has an attenuation ratio of 100:1. It should be noted that its AC_{peak} value is derated at higher frequencies. If a normal x10 probe is used to measure high voltages there is the risk that the compensation trimmer bridging the attenuator series resistor will break down causing damage to the input of the oscilloscope. However, if for example only the residual ripple of a high voltage is to be displayed on the oscilloscope, a normal x10 probe is sufficient. In this case, an appropriate high voltage capacitor (approx. 22-68 nF) must be connected in series with the input tip of the probe.

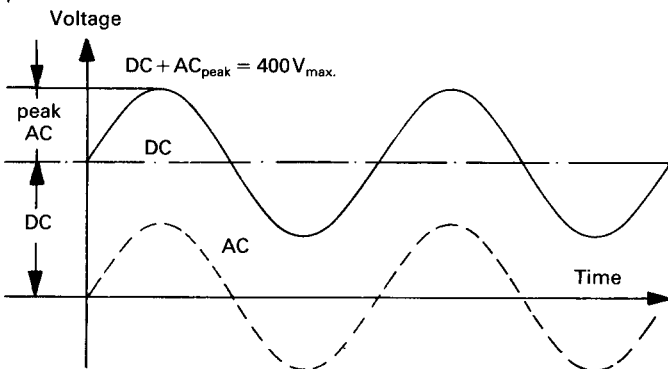

Total value of input voltage
The dotted line shows a voltage alternating at zero volt level. When superimposed a DC level, the addition of the positive peak and the DC voltage results in the max. voltage ($DC + AC_{peak}$).

It is very important that the oscilloscope input coupling is set to **DC**, if an attenuator probe is used for voltages higher than 400V (see page M5: Connection of Test Signal).

With **Y-POS.** control (input coupling to **GD**) it is possible to set a horizontal graticule line as **reference line for ground potential** before the measurement. It can lie below or above the horizontal central line according to whether positive and/or negative deviations from the ground potential are to be measured. Certain switchable x10/x1 attenuator probes also have a built-in ground reference switch position.

Time Measurements

As a rule, most signals to be displayed are periodically repeating processes, also called periods. The number of periods per second is the repetition frequency. Depending on the time base setting of the **TIME/DIV.** switch, one or several signal periods or only a part of a period can be displayed. The time coefficients are stated in **ms/cm** and **$\mu\text{s/cm}$** on the **TIME/DIV.**-switch. The scale is accordingly divided into two fields.

The duration of a signal period or a part of it is determined by multiplying the relevant time (horizontal distance in cm) by the time coefficient set on the TIME/DIV.-switch.

The variable time control (identified with an arrow knob cap) must be in its calibrated position CAL. (arrow pointing horizontally to the left).

With the designations

L = displayed wave **length in cm** of one period,

T = **time in seconds** for one period,

F = recurrence **frequency in Hz** of the signal,

T_c = **time coefficient in s/cm** on timebase switch and the relation **$F = 1/T$** , the following equations can be stated:

$$T = L \cdot T_c \qquad L = \frac{T}{T_c} \qquad T_c = \frac{T}{L}$$

$$F = \frac{1}{L \cdot T_c} \qquad L = \frac{1}{F \cdot T_c} \qquad T_c = \frac{1}{L \cdot F}$$

With depressed X-MAG. x10 pushbutton the T_c value must be divided by 10.

However, these four values are not freely selectable. They have to be within the following limits:

L between 0.2 and 10 cm, if possible 4 to 10 cm,

T between $0.05 \mu\text{s}$ and 2 s,

F between 0.5 Hz and 20 MHz,

T_c between $0.5 \mu\text{s/cm}$ and 0.2 s/cm in 1-2-5 sequence (with **X-MAG. x10** in out position), and

T_c between 50 ns/cm and 20 ms/cm in 1-2-5 sequence (with pushed **X-MAG. x10** pushbutton).

Examples:

Displayed wavelength $L = 7\text{ cm}$,
 set time coefficient $T_c = 0.5\ \mu\text{s/cm}$,
required period $T = 7 \cdot 0.5 \cdot 10^{-6} = 3.5\ \mu\text{s}$
required rec. freq. $F = 1 : (3.5 \cdot 10^{-6}) = 286\ \text{kHz}$

Signal period $T = 0.5\text{ s}$,
 set time coefficient $T_c = 0.2\ \text{s/cm}$,
required wavelength $L = 0.5 : 0.2 = 2.5\ \text{cm}$.

Displayed ripple wavelength $L = 1\ \text{cm}$,
 set time coefficient $T_c = 10\ \text{ms/cm}$,
required ripple freq. $F = 1 : (1 \cdot 10 \cdot 10^{-3}) = 100\ \text{Hz}$.

TV-line frequency $F = 15\ 625\ \text{Hz}$,
 set time coefficient $T_c = 10\ \mu\text{s/cm}$,
required wavelength $L = 1 : (15\ 625 \cdot 10^{-5}) = 6.4\ \text{cm}$.

Sine wavelength $L = \text{min. } 4\ \text{cm, max. } 10\ \text{cm}$,
 Frequency $F = 1\ \text{kHz}$,
 max. time coefficient $T_c = 1 : (4 \cdot 10^3) = 0.25\ \text{ms/cm}$,
 min. time coefficient $T_c = 1 : (10 \cdot 10^3) = 0.1\ \text{ms/cm}$,
set time coefficient $T_c = 0.2\ \text{ms/cm}$,
required wavelength $L = 1 : (10^3 \cdot 0.2 \cdot 10^{-3}) = 5\ \text{cm}$.

Displayed wavelength $L = 0.8\ \text{cm}$,
 set time coefficient $T_c = 0.5\ \mu\text{s/cm}$,
pressed X-MAG. x10 button: $T_c = 0.05\ \mu\text{s/cm}$,
required rec. freq. $F = 1 : (0.8 \cdot 0.05 \cdot 10^{-6}) = 25\ \text{MHz}$,
required period $T = 1 : (25 \cdot 10^6) = 40\ \text{ns}$.

If the time is relatively short as compared with the complete signal period, an expanded time scale should always be applied (**X-MAG. x10** button pressed). In this case, the ascertained time values have to be divided by **10**. The time interval of interest can be shifted to the screen center using the **X-POS.** control.

When investigating pulse or square waveforms, the critical feature is the **risetime of the voltage step**. To ensure that transients, ramp-offs, and bandwidth limits do not unduly influence the measuring accuracy, the risetime is generally measured between **10%** and **90%** of the vertical pulse height. For peak-to-peak signal amplitude of **5cm** height, which are symmetrically adjusted to the horizontal center line, the internal graticule of the CRT has two horizontal dotted lines $\pm 2.5\text{cm}$ from the center line. Adjust the Y attenuator switch with its variable control together with the **Y-POS.** control so that the pulse height is precisely aligned with these 0 and 100% lines. The 10% and 90% points of the signal will now coincide with the two lines, which have a distance of $\pm 2\text{cm}$ from the horizontal center line and an additional subdivision of 0.2cm. **The risetime is given by the product of the horizontal distance in cm between these two coincidence points and the time coefficient setting.** If magnification is used, this product must be divided by 10. The **fall time** of a pulse can also be measured by using this method.

The following figure shows correct positioning of the oscilloscope trace for accurate risetime measurement.

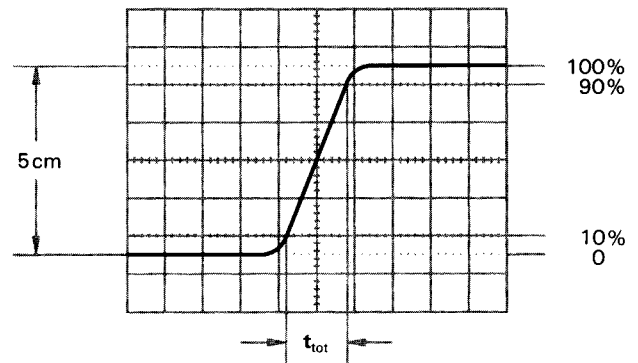

With a time coefficient of $0.5\ \mu\text{s/cm}$ and pushed **X-MAG x10** button the example shown in the above figure results in a measured total risetime of

$$t_{tot} = 1.6\ \text{cm} \cdot 0.5\ \mu\text{s/cm} : 10 = 80\ \text{ns}$$

When very fast risetimes are being measured, the risetimes of the oscilloscope amplifier and of the attenuator probe has to be deducted from the measured time value. The risetime of the signal can be calculated using the following formula.

$$t_r = \sqrt{t_{tot}^2 - t_{osc}^2 - t_p^2}$$

In this t_{tot} is the total measured risetime, t_{osc} is the risetime of the oscilloscope amplifier (approx. 17,5ns), and t_p the risetime of the probe (e.g. = 2ns). If t_{tot} is greater than 100ns, then t_{tot} can be taken as the risetime of the pulse, and calculation is unnecessary.

Calculation of the example in the figure above results in a signal risetime

$$t_r = \sqrt{80^2 - 17.5^2 - 2^2} = 78.04\ \text{ns}$$

The measurement of the rise or fall time is not limited to the trace dimensions shown in the above diagram. It is only particularly simple in this way. In principle it is possible to measure in any display position and at any signal amplitude. It is only important that the full height of the signal edge of interest is visible in its full length at not too great steepness and that the horizontal distance at 10% and 90% of the amplitude is measured. If the edge shows rounding or overshooting, the 100% should not be related to the peak values but to the mean pulse heights. Breaks or peaks (glitches) next to the edge are also not taken into account. With very severe transient distortions, the rise and fall time measurement has little sense. For amplifiers with approximately constant group delay (therefore good pulse transmission performance) the following numerical relationship between rise time t_r (in ns) and bandwidth B (in MHz) applies:

$$t_r = \frac{350}{B} \quad B = \frac{350}{t_r}$$

Connection of Test Signal

Caution: When connecting unknown signals to the oscilloscope input, always use automatic triggering and set the **DC-AC** input coupling switch to **AC**. The attenuator switch should initially be set to **20V/cm**.

Sometimes the trace will disappear after an input signal has been applied. The attenuator switch must then be turned back to the left, until the vertical signal height is only 3-8cm. With a signal amplitude greater than $160V_{pp}$, an attenuator probe must be inserted before the oscilloscope's vertical input. If, after applying the signal, the trace is nearly blanked, the period of the signal is probably substantially longer than the set value on the **TIME/DIV.** switch. It should be turned to the left to an adequately larger time coefficient.

The signal to be displayed can be connected directly to the Y-input of the oscilloscope with a shielded test cable such as HZ 32 and HZ 34 or attenuated through a x10 or x100 attenuator probe. The use of test cables with high impedance circuits is only recommended for relatively low frequencies (up to approx. 50 kHz). For higher frequencies, the signal source must be of low impedance, i.e. matched to the characteristic resistance of the cable (as a rule 50 Ohm). Especially when transmitting square and pulse signals, a resistor equal to the characteristic impedance of the cable must also be connected across the cable directly at the Y-input of the oscilloscope. When using a 50 Ohm cable such as the HZ 34, a 50 Ohm through termination type HZ22 is available from HAMEG. When transmitting square signals with short rise times, transient phenomena on the edges and top of the signal may become visible if the correct termination is not used. A terminating resistance is sometimes recommended with sine signals as well. Certain amplifiers, generators or their attenuators maintain the nominal output voltage independent of frequency only if their connection cable is terminated with the prescribed resistance. Here it must be noted that the terminating resistor HZ 22 will only dissipate a maximum of 2 Watts. This power is reached with $10V_{rms}$ or – at $28.3V_{pp}$ with sine signal.

If a x10 or x100 attenuator probe is used, no termination is necessary. In this case, the connecting cable is matched directly to the high impedance input of the oscilloscope. When using attenuator probes, even high internal impedance sources are only slightly loaded (approx. $10M\Omega \parallel 16pF$ or $100M\Omega \parallel 7pF$ with HZ 53). Therefore, if the voltage loss due to the attenuation of the probe can be compensated by a higher amplitude setting, the probe should always be used. The series impedance of the probe provides a certain amount of protection for the input of the vertical amplifier. Because of their separate manufacture, all attenuator probes are only partially compensated, therefore

accurate compensation must be performed on the oscilloscope (see "Probe compensation" page M8).

Standard attenuator probes on the oscilloscope normally reduce its bandwidth and increase the rise time. In all cases where the oscilloscope band width must be fully utilized (e.g. for pulses with steep edges) we strongly advise using the **modular probes HZ 51** (x10) **HZ 52** (x10 HF) and **HZ 54** or **HZ 37** (x1 and x10) (see oscilloscope accessories, page Z1). This can save the purchase of an oscilloscope with larger bandwidth and has the advantage that defective components can be ordered from HAMEG and replaced by oneself. The probes mentioned have a HF-calibration in addition to low frequency calibration adjustment. Thus a group delay correction to the upper limit frequency of the oscilloscope is possible with the aid of an 1 MHz calibrator, e.g. HZ60. In fact the bandwidth and rise time of the oscilloscope are not noticeably changed with these probe types and the waveform reproduction fidelity can even be improved because the probe can be matched to the oscilloscope's individual pulse response.

If a x10 or x100 attenuator probe is used, DC input coupling must always be used at voltages above 400 V. With **AC** coupling of low frequency signals, the attenuation is no longer independent of frequency, pulses can show pulse tilts. Direct voltages are suppressed but load the oscilloscope input coupling capacitor concerned. Its voltage rating is max. 400 V (DC + peak AC). **DC** input coupling is therefore of quite special importance with a x100 attenuation probe which usually has a voltage rating of max. 1200 V (DC + peak AC). A **capacitor** of corresponding capacitance and voltage rating may be connected **in series with the attenuator** probe input for blocking DC voltage (e.g. for hum voltage measurement).

With all **attenuator probes, the maximum AC input voltage** must be **derated** with frequency usually above 20 kHz. Therefore the derating curve of the attenuator probe type concerned must be taken into account.

The selection of the ground point on the test object is important when displaying small signal voltages. It should always be as close as possible to the measuring point. If this is not done, serious signal distortion may result from spurious currents through the ground leads or chassis parts. The ground leads on attenuator probes are also particularly critical. They should be as short and thick as possible. When the attenuator probe is connected to a BNC-socket, a BNC-adaptor, which is often supplied as probe accessory, should be used. In this way ground and matching problems are eliminated.

Hum or interference appearing in the measuring circuit (especially when a small deflection coefficient is used) is possibly caused by multiple grounding because equalizing

currents can flow in the shielding of the test cables (voltage drop between the protective conductor connections, caused by external equipment connected to the mains/line, e.g. signal generators with interference protection capacitors).

First Time Operation

Check that the instrument is set to the correct mains/line voltage. (Refer to page M2).

Before applying power to the oscilloscope it is recommended that the following simple procedures are performed:

- Check that all pushbuttons are in the **out** position, i.e. released.
- Rotate the four variable controls with arrows, i.e. **TIME/DIV.** variable control, **CH.I** and **CH.II** attenuator variable controls, and **HOLD OFF** control fully counter-clockwise to their calibrated detent.
- Set all controls with marker lines to their midrange position (marker lines pointing vertically).
- The **TV SEP.** lever switch and the **TRIG.** selector lever switch in the X-field should be set to their uppermost position.
- Both **DC-AC-GD** input coupling slide switches for **CH.I** and **CH.II** in the Y-field should be set to the **GD** position.

Switch on the oscilloscope by depressing the red **POWER** pushbutton. An LED will illuminate to indicate working order. The trace, displaying one baseline, should be visible after a short warm-up period of 10 seconds. Adjust **Y-POS.I** and **X-POS.** controls to center the baseline. Adjust **INTENS.** (intensity) and **FOCUS** controls for medium brightness and optimum sharpness of the trace. The oscilloscope is now ready for use.

If only a spot appears (**CAUTION!** CRT phosphor can be damaged.), reduce the intensity immediately and check that the **X-Y** pushbutton is in the released (out) position. If the trace is not visible, check the correct positions of all knobs and switches (particularly **AT/NORM.** button in out position).

To obtain the maximum life from the cathode-ray tube, the minimum intensity setting necessary for the measurement in hand and the ambient light conditions should be used.

Particular care is required when a single spot is displayed, as a very high intensity setting may cause damage

to the fluorescent screen of the CRT. Switching the oscilloscope off and on at short intervals stresses the cathode of the CRT and should therefore be avoided.

The instrument is so designed that even incorrect operation will not cause serious damage. The pushbuttons control only minor functions, and it is recommended that before commencement of operation all pushbuttons are in the "out" position. After this the pushbuttons can be operated depending upon the mode of operation required.

The HM203-6 accepts all signals from DC (direct voltage) up to a frequency of at least 20MHz (-3dB). For sinewave voltages the upper frequency limit will be 30-35MHz.

However, in this higher frequency range the vertical display height on the screen is limited to approx. 4-5cm. The time resolution poses no problem. For example, with 25MHz and the fastest adjustable sweep rate (20 ns/cm), one cycle will be displayed every 2 cm. The tolerance on indicated values amounts to $\pm 3\%$ in both deflection directions. All values to be measured can therefore be determined relatively accurately. However, from approximately 6MHz upwards the measuring error will increase as a result of loss of gain. At 12MHz this reduction is about 10%. Thus, approximately 11% should be added to the measured voltage at this frequency. As the bandwidth of the amplifiers differ (normally between 20 and 25MHz), the measured values in the upper limit range cannot be defined exactly. Additionally, as already mentioned, for frequencies above 20MHz the dynamic range of the display height steadily decreases. The vertical amplifier is designed so that the transmission performance is not affected by its own overshoot.

Trace Rotation TR

In spite of Mumetal-shielding of the CRT, effects of the earth's magnetic field on the horizontal trace position cannot be completely avoided. This is dependent upon the orientation of the oscilloscope on the place of work. A centred trace may not align exactly with the horizontal center line of the graticule. A few degrees of misalignment can be corrected by a potentiometer accessible through an opening on the front panel marked TR.

DC Balance Adjustment

The vertical preamplifiers for **CH.I** and **CH.II** contain matched dual FETs connected as input source followers. After long periods of use the FET characteristics may change which can alter the DC balance of the vertical amplifier.

A quick check can be made on each channel by rotating the variable control knob on the attenuator switch to and fro,

clockwise and back to the calibrated detent **CAL.** If the trace moves from the vertical position (up or down) more than 1 mm, the DC balance will require readjustment. This check should be made after a 20 minute warm-up period.

Adjustment procedure

The following instructions should be performed to obtain the correct DC balance adjustment of both channels.

- Remove all input cables and adjust oscilloscope controls to display the baseline.
- Center the baseline using **Y-POS.** and **X-POS.** controls.
- Set attenuator switches to **5 mV/cm** and input coupling switches to **GD.**
- Release all pushbuttons in the Y-field.
- Place the oscilloscope so that it rests firmly on its back (up-right position) and locate DC balance adjustment potentiometer access holes – marked **CH.I DC-BALANCE CH.II** – which are found underneath the instrument.
- Insert a screwdriver (blade approx. 3mm, length min. 20mm) in **CH.I** hole. A plastic guide with slotted bottom is located behind the hole.
- Rotate **VOLTS/DIV.** variable control to and fro and adjust balance pot so that the baseline no longer moves up or down. When the trace remains steady, correction of **CH.I** is completed.
- Depress **CHI/II** button. Repeat adjustment procedure for **CH.II.**

Probe compensation and use

The attenuator probe must be matched exactly to the input impedance of the vertical amplifier to ensure an undistorted display of waveforms. A generator built into the HM 203-6 supplies a square wave signal for this purpose with very short rise time (<5 ns) at **1 kHz.** The square wave signal can be taken from the two eyelets beneath the screen. One output supplies **0.2V_{pp} ±1%** for x10 attenuator probes, the other **2V_{pp} ±1%** for x100 attenuator probes. These voltages correspond in each case to a screen amplitude of **4 cm** provided the input attenuator switch of the HM 203-6 is set to the deflection coefficient **5 mV/cm.**

1 kHz compensation

This trimmer adjustment compensates the capacitive loading of the oscilloscope input (approx. 30 pF for the HM 203-6). After compensation, the capacitive attenuation has the

same attenuation ratio as the ohmic divider. The same voltage attenuation then results at high and low frequencies as for direct voltage (for x1 probes or probes switches over to x1, this compensation is neither necessary nor possible). The trace line must be parallel with the horizontal graticule lines (see "Trace rotation **TR**", page M7).

Connect attenuator probe (type HZ 51, 52, 53, 54 or also HZ 36 and HZ 37) to the **CH.I** input, do not press any buttons or turn any knobs, set input coupling to **DC,** input attenuator to **5 mV/cm** and **TIME/DIV.** switch to **0.2 ms/cm** (both variable controls in calibration position **CAL.**), connect probe to the corresponding **CAL.** eyelet (x10 probe to **0.2 V** eyelet, x100 to **2 V** eyelet).

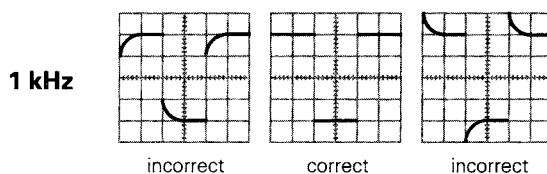

2 cycles can be seen on the screen. The compensation trimmer must now be adjusted. It is generally located in the probe itself. It is located in the x100 attenuator probe HZ53 in the small box on the BNC plug. Adjust the trimmer with the insulating screw driver provided until the tops of the square wave signal are exactly parallel to the horizontal graticule lines (see 1 kHz diagram). The signal height should then be 4 cm ±1.2 mm (= 3 %). The signal edges are invisible during this adjustment.

1 MHz compensation

HF adjustment is possible for the HZ37, 51, 52, and 54 probes. These possess resonance correction elements (pots in combination with coils and capacitors) with which it is possible for the first time to simply adjust the probe in the upper frequency range of the vertical amplifier.

After this compensation, not only the maximum possible bandwidth is obtained in the attenuator probe mode but also a largely constant group delay at the end of the bandwidth. In this way transient distortions (such as overshooting, rounding off, ringing, holes or humps in the pulse top) in the vicinity of the leading edge are kept to a minimum. The bandwidth of the HM 203-6 is therefore fully utilized when using the HZ37, 51, 52 and 54 probes without having to accept wave form distortions.

Prerequisite for this HF compensation is a square wave generator with short rise time (typically 4 ns) and low-impedance output (approx. 50 Ohm) which also supplies a voltage of 0.25 V or 2.5 V at a frequency of 1 MHz.

The **Scope Tester HZ60** fulfills these tasks excellently (see **Accessories,** page Z1).

currents can flow in the shielding of the test cables (voltage drop between the protective conductor connections, caused by external equipment connected to the mains/line, e.g. signal generators with interference protection capacitors).

First Time Operation

Check that the instrument is set to the correct mains/line voltage. (Refer to page M2).

Before applying power to the oscilloscope it is recommended that the following simple procedures are performed:

- Check that all pushbuttons are in the **out** position, i.e. released.
- Rotate the four variable controls with arrows, i.e. **TIME/DIV.** variable control, **CH.I** and **CH.II** attenuator variable controls, and **HOLD OFF** control fully counter-clockwise to their calibrated detent.
- Set all controls with marker lines to their midrange position (marker lines pointing vertically).
- The **TV SEP.** lever switch and the **TRIG.** selector lever switch in the X-field should be set to their uppermost position.
- Both **DC-AC-GD** input coupling slide switches for **CH.I** and **CH.II** in the Y-field should be set to the **GD** position.

Switch on the oscilloscope by depressing the red **POWER** pushbutton. An LED will illuminate to indicate working order. The trace, displaying one baseline, should be visible after a short warm-up period of 10 seconds. Adjust **Y-POS.I** and **X-POS.** controls to center the baseline. Adjust **INTENS.** (intensity) and **FOCUS** controls for medium brightness and optimum sharpness of the trace. The oscilloscope is now ready for use.

If only a spot appears (**CAUTION!** CRT phosphor can be damaged.), reduce the intensity immediately and check that the **X-Y** pushbutton is in the released (out) position. If the trace is not visible, check the correct positions of all knobs and switches (particularly **AT/NORM.** button in out position).

To obtain the maximum life from the cathode-ray tube, the minimum intensity setting necessary for the measurement in hand and the ambient light conditions should be used.

Particular care is required when a single spot is displayed, as a very high intensity setting may cause damage

to the fluorescent screen of the CRT. Switching the oscilloscope off and on at short intervals stresses the cathode of the CRT and should therefore be avoided.

The instrument is so designed that even incorrect operation will not cause serious damage. The pushbuttons control only minor functions, and it is recommended that before commencement of operation all pushbuttons are in the "out" position. After this the pushbuttons can be operated depending upon the mode of operation required.

The HM203-6 accepts all signals from DC (direct voltage) up to a frequency of at least 20MHz (-3dB). For sinewave voltages the upper frequency limit will be 30-35MHz.

However, in this higher frequency range the vertical display height on the screen is limited to approx. 4-5cm. The time resolution poses no problem. For example, with 25MHz and the fastest adjustable sweep rate (20ns/cm), one cycle will be displayed every 2cm. The tolerance on indicated values amounts to $\pm 3\%$ in both deflection directions. All values to be measured can therefore be determined relatively accurately. However, from approximately 6MHz upwards the measuring error will increase as a result of loss of gain. At 12MHz this reduction is about 10%. Thus, approximately 11% should be added to the measured voltage at this frequency. As the bandwidth of the amplifiers differ (normally between 20 and 25 MHz), the measured values in the upper limit range cannot be defined exactly. Additionally, as already mentioned, for frequencies above 20MHz the dynamic range of the display height steadily decreases. The vertical amplifier is designed so that the transmission performance is not affected by its own overshoot.

Trace Rotation TR

In spite of Mumetal-shielding of the CRT, effects of the earth's magnetic field on the horizontal trace position cannot be completely avoided. This is dependent upon the orientation of the oscilloscope on the place of work. A centred trace may not align exactly with the horizontal center line of the graticule. A few degrees of misalignment can be corrected by a potentiometer accessible through an opening on the front panel marked TR.

DC Balance Adjustment

The vertical preamplifiers for **CH.I** and **CH.II** contain matched dual FETs connected as input source followers. After long periods of use the FET characteristics may change which can alter the DC balance of the vertical amplifier.

A quick check can be made on each channel by rotating the variable control knob on the attenuator switch to and fro,

clockwise and back to the calibrated detent **CAL**. If the trace moves from the vertical position (up or down) more than 1 mm, the DC balance will require readjustment. This check should be made after a 20 minute warm-up period.

Adjustment procedure

The following instructions should be performed to obtain the correct DC balance adjustment of both channels.

- Remove all input cables and adjust oscilloscope controls to display the baseline.
- Center the baseline using **Y-POS.** and **X-POS.** controls.
- Set attenuator switches to **5 mV/cm** and input coupling switches to **GD**.
- Release all pushbuttons in the Y-field.
- Place the oscilloscope so that it rests firmly on its back (upright position) and locate DC balance adjustment potentiometer access holes – marked **CH.I DC-BALANCE CH.II** – which are found underneath the instrument.
- Insert a screwdriver (blade approx. 3mm, length min. 20mm) in **CH.I** hole. A plastic guide with slotted bottom is located behind the hole.
- Rotate **VOLTS/DIV.** variable control to and fro and adjust balance pot so that the baseline no longer moves up or down. When the trace remains steady, correction of **CH.I** is completed.
- Depress **CHI/II** button. Repeat adjustment procedure for **CH.II**.

Probe compensation and use

The attenuator probe must be matched exactly to the input impedance of the vertical amplifier to ensure an undistorted display of waveforms. A generator built into the HM 203-6 supplies a square wave signal for this purpose with very short rise time (<5 ns) at **1 kHz**. The square wave signal can be taken from the two eyelets beneath the screen. One output supplies **0.2V_{pp} ±1%** for x10 attenuator probes, the other **2V_{pp} ±1%** for x100 attenuator probes. These voltages correspond in each case to a screen amplitude of **4 cm** provided the input attenuator switch of the HM 203-6 is set to the deflection coefficient **5 mV/cm**.

1 kHz compensation

This trimmer adjustment compensates the capacitive loading of the oscilloscope input (approx. 30 pF for the HM 203-6). After compensation, the capacitive attenuation has the

same attenuation ratio as the ohmic divider. The same voltage attenuation then results at high and low frequencies as for direct voltage (for x1 probes or probes switches over to x1, this compensation is neither necessary nor possible). The trace line must be parallel with the horizontal graticule lines (see "Trace rotation **TR**", page M7).

Connect attenuator probe (type HZ 51, 52, 53, 54 or also HZ 36 and HZ 37) to the **CH.I** input, do not press any buttons or turn any knobs, set input coupling to **DC**, input attenuator to **5 mV/cm** and **TIME/DIV.** switch to **0.2 ms/cm** (both variable controls in calibration position **CAL.**), connect probe to the corresponding **CAL.** eyelet (x10 probe to **0.2 V** eyelet, x100 to **2 V** eyelet).

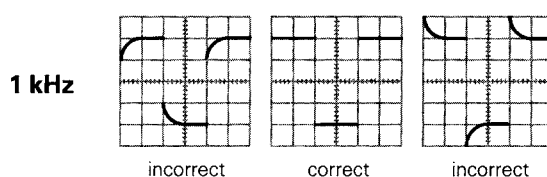

2 cycles can be seen on the screen. The compensation trimmer must now be adjusted. It is generally located in the probe itself. It is located in the x100 attenuator probe HZ53 in the small box on the BNC plug. Adjust the trimmer with the insulating screw driver provided until the tops of the square wave signal are exactly parallel to the horizontal graticule lines (see 1 kHz diagram). The signal height should then be 4 cm ±1.2 mm (= 3 %). The signal edges are invisible during this adjustment.

1 MHz compensation

HF adjustment is possible for the HZ37, 51, 52, and 54 probes. These possess resonance correction elements (pots in combination with coils and capacitors) with which it is possible for the first time to simply adjust the probe in the upper frequency range of the vertical amplifier.

After this compensation, not only the maximum possible bandwidth is obtained in the attenuator probe mode but also a largely constant group delay at the end of the bandwidth. In this way transient distortions (such as overshooting, rounding off, ringing, holes or humps in the pulse top) in the vicinity of the leading edge are kept to a minimum. The bandwidth of the HM 203-6 is therefore fully utilized when using the HZ37, 51, 52 and 54 probes without having to accept wave form distortions.

Prerequisite for this HF compensation is a square wave generator with short rise time (typically 4 ns) and low-impedance output (approx. 50 Ohm) which also supplies a voltage of 0.25 V or 2.5 V at a frequency of 1 MHz.

The **Scope Tester HZ60** fullfills these tasks excellently (see **Accessories**, page Z1).

Operating modes of the vertical amplifiers

The desired operating mode of the vertical amplifiers is selected with the 3 buttons in the Y field. All three buttons out for **mono** mode. Only **Channel I** is then operational. The button **CHI/CHII** must be depressed in mono mode for **Channel II**. The internal triggering is simultaneously switched over to Channel II with this button.

If the **DUAL** button is depressed, both channels are working. Two signals can be displayed together in this button position (alternate mode). This mode is not suitable for displaying very slow-running processes. The display then flickers too much or it appears to jump. If the **CHOP** button is depressed in addition to **DUAL**, both channels are switched over constantly at a high frequency within a sweep period (CHOP mode). Slow running processes **below 1 kHz or with time coefficients higher than 1 ms/cm** are then also displayed without flicker. The dual mode chosen is less important for signals with higher repetition frequency.

If the **ADD** button is depressed, the signals of both channels are algebraically added ($\pm I \pm II$). Whether the resulting display shows the **sum** or **difference** is dependent on the phase relationship or the polarity of the signals **and** on the positions of both **INVERT** buttons.

In-phase input voltages:

- Both **INVERT** buttons released = sum.
- Both **INVERT** buttons depressed = sum.
- Only one **INVERT** button depressed = difference.

Antiphase input voltages:

- Both **INVERT** buttons released = difference.
- Both **INVERT** buttons depressed = difference.
- Only one **INVERT** button depressed = sum.

In the **ADD** mode the vertical display position is dependent upon the **Y-POS.** setting of **both** channels. The **same attenuator switch position** is normally used for both channels with algebraic addition.

Differential measurement techniques allow direct measurement of the voltage drop across floating components (both ends above ground). Two identical probes should be used for both vertical inputs. Using a separate ground connection and **not** connecting the probe or cable shields to the circuit under test avoid ground loops (hum, common-mode disturbances).

X-Y Operation

For **X-Y operation**, the pushbutton in the X field marked **X-Y** must be depressed. The X signal is then derived from the **Channel II (HOR. INP.)**. **The calibration of the X signal during X-Y operation is determined by the setting of the Channel II input attenuator and variable control.**

This means that the sensitivity ranges and input impedances are identical for both the X and Y axes. However, the **Y-POS.II** control is disconnected in this mode. Its function is taken over by the **X-POS.** control. It is important to note that the **X-MAG. x10** facility, normally used for expanding the sweep, should not be operated in the X-Y mode. It should also be noted that the bandwidth of the X amplifier is approximately 2.5 MHz (-3dB), and therefore an increase in phase difference between both axes is noticeable from 50 kHz upwards.

The Y-Input signal may be inverted by using the **INVERT** facility. However, the inversion of the X-input signal using the CH. II **INVERT** button is not possible.

Lissajous figures can be displayed in the **X-Y mode** for certain measuring tasks:

- Comparing two signals of different frequency or bringing one frequency up to the frequency of the other signal. This also applies for whole number multiples or fractions of the one signal frequency.
- Phase comparison between two signals of the same frequency.

Phase comparison with Lissajous figure

The following diagrams show two sine signals of the same frequency and amplitude with different phase angles.

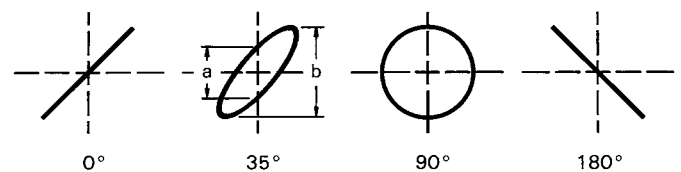

Calculation of the phase angle or the phase shift between the X and Y input voltages (after measuring the distances **a** and **b** on the screen) is quite simple with the following formula and a pocket calculator with trigonometric functions and besides **independent of both deflecting amplitudes** on the screen.

$$\sin \varphi = \frac{a}{b}$$

$$\cos \varphi = \sqrt{1 - \left(\frac{a}{b}\right)^2}$$

$$\varphi = \arcsin \frac{a}{b}$$

The following must be noted here:

- Because of the periodic nature of the trigonometric functions, the calculation should be limited to angles $\leq 90^\circ$. However here is the advantage of the method.
- Do not use a too high test frequency. The phase shift of the two oscilloscope amplifiers of the HM 203-6 in the X-Y mode can exceed an angle of 3° above 120 kHz.
- It cannot be seen as a matter of course from the screen display if the test voltage leads or lags the reference voltage. A CR network before the test voltage input of the oscilloscope can help here. The 1 M Ω input resistance

can equally serve as R here, so that only a suitable capacitor C needs to be connected in series. If the aperture width of the ellipse is increased (compared with C short-circuited), then the test voltage leads the reference voltage and vice versa. This applies only in the region up to 90° phase shift. Therefore C should be sufficiently large and produce only a relatively small just observable phase shift.

Should both input voltages be missing or fail in the X-Y mode, a very bright light dot is displayed on the screen. This dot can burn into the phosphor at a too high brightness setting (INTENS. knob) which causes either a lasting loss of brightness, or in the extreme case, complete destruction of the phosphor at this point.

Phase difference measurement in DUAL mode

A larger phase difference between two input signals of the same frequency and shape can be measured very simply on the screen in Dual mode (DUAL button depressed). The time base should be triggered by the reference signal (phase position 0). The other signal can then have a leading or lagging phase angle. Alternate mode should be selected for frequencies ≥ 1 kHz; the Chop mode is more suitable for frequencies < 1 kHz (less flickering). For greatest accuracy adjust not much more than one period and approximately the same height of both signals on the screen. The variable controls for amplitude and time base and the LEVEL knob can also be used for this adjustment – without influence on the result. Both base lines are set onto the horizontal graticule center line with the Y-POS. knobs before the measurement. With sinusoidal signals, observe the zero (crossover point) transitions; the sine peaks are less accurate. If a sine signal is noticeably distorted by even harmonics, or if an offset direct voltage is present, AC coupling is recommended for both channels. If it is a question of pulses of the same shape, read off at steep edges.

Phase difference measurement in dual mode

t = horizontal spacing of the zero transitions in cm.

T = horizontal spacing for one period in cm.

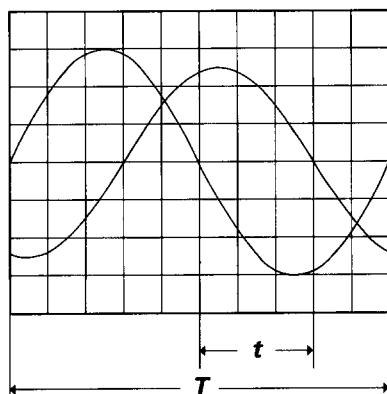

In the example illustrated, $t = 3$ cm and $T = 10$ cm. The phase difference in degrees is calculated from

$$\varphi^\circ = \frac{t}{T} \cdot 360^\circ = \frac{3}{10} \cdot 360^\circ = 108^\circ$$

or expressed in radians

$$\text{arc } \varphi = \frac{t}{T} \cdot 2\pi = \frac{3}{10} \cdot 2\pi = 1,885 \text{ rad}$$

Relatively small phase angles at not too high frequencies can be measured more accurately in the X-Y mode with Lissajous figures.

Measurement of an amplitude modulation

The momentary amplitude u at time t of a HF-carrier voltage, which is amplitude modulated without distortion by a sinusoidal AF voltage, is in accordance with the equation

$$u = U_T \cdot \sin \Omega t + 0,5m \cdot U_T \cdot \cos(\Omega - \omega)t - 0,5m \cdot U_T \cdot \cos(\Omega + \omega)t$$

where U_T = unmodulated carrier amplitude
 $\Omega = 2\pi F$ = angular carrier frequency
 $\omega = 2\pi f$ = modulation angular frequency
 m = modulation factor ($\leq 1 \triangleq 100\%$).

The lower side frequency $F-f$ and the upper side frequency $F+f$ arise because of the modulation apart from the carrier frequency F .

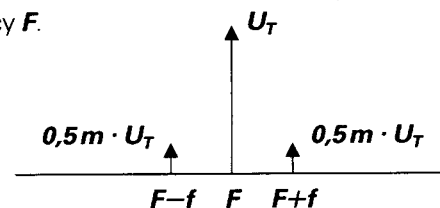

Figure 1
Amplitude and frequency spectrum for AM display ($m = 50\%$)

The display of the amplitude-modulated HF oscillation can be evaluated with the oscilloscope provided the frequency spectrum is inside the oscilloscope bandwidth. The time base is set so that several wave of the modulation frequency are visible. Strictly speaking, triggering should be external with modulation frequency (from the AF generator or a demodulator). However, internal triggering is frequently possible with normal triggering (AT-NORM. button depressed) using a suitable LEVEL setting and possibly also using the time variable adjustment.

Figure 2
Amplitude modulated oscillation: $F = 1$ MHz; $f = 1$ kHz;
 $m = 50\%$; $U_T = 28.3$ mV_{rms}.

Oscilloscope setting for a signal according to figure 2:

Depress no buttons. **Y: CH. I; 20mV/cm; AC.**

TIME/DIV.: 0.2ms/cm.

Triggering: **NORMAL** with **LEVEL**-setting; **internal (or external) triggering.**

If the two values **a** and **b** are read from the screen, the modulation factor is calculated from

$$m = \frac{a - b}{a + b} \text{ bzw. } m = \frac{a - b}{a + b} \cdot 100 [\%]$$

where **a** = $U_T(1+m)$ and **b** = $U_T(1-m)$.

The variable controls for amplitude and time can be set arbitrarily in the modulation factor measurement. Their position does not influence the result.

Triggering and time base

A signal can be displayed only if the time base is running or triggered. To produce a stationary display, triggering must be synchronous with the test signal. This is possible by using the test signal itself or by an externally supplied but synchronous signal voltage.

The trigger voltage should have a certain minimum amplitude. This value is called the **trigger threshold**. It is measured with a sine signal. When the trigger voltage is taken internally from the test signal, the trigger threshold can be stated as vertical **display height in mm**, through which the time base generator starts, the display is stable, and the trigger LED lights.

The internal trigger threshold of the HM203-6 is given as ≤ 5 mm. When the trigger voltage is externally supplied, it can be measured in V_{pp} at the **TRIG. INP.** socket. Normally, the trigger threshold may be exceeded up to a maximum factor of 20.

The HM203-6 has two trigger modes, which are characterized in the following.

Automatic Triggering

If the **AT/NORM.** pushbutton in the X field is in the out position **AT**, the sweep generator is running without test signal or external trigger voltage. A base line is always displayed even without a signal applied. This trigger mode is therefore called **Automatic Triggering**. Operation of the scope needs, having a constantly visible trace, only a correct amplitude and time base setting. A **LEVEL** adjustment is neither necessary nor possible with automatic triggering. This simple **AT** mode is recommended for all uncomplicated measuring tasks. However, automatic triggering is also the appropriate operation mode for the "entry" into dif-

ficult measuring problems, e.g. when the test signal is unknown relating to amplitude, frequency or shape. Presetting of all parameters is now possible with automatic triggering; the change to normal triggering can follow thereafter.

The automatic triggering works above **10Hz** up to at least **20MHz**. The changeover to the break down of the automatic triggering at frequencies under 10Hz is abrupt. However, it can not be recognized by the **TRIG. LED**; this is still blinking. Break down of triggering is best recognizable at the left screen edge (the start of the trace in differing display height).

The automatic triggering follows immediately all variations or fluctuations of the test signal above 10Hz. However, if the pulse duty factor of a square-wave signal changes so much that one part of the square-wave reduces to a needle pulse, switching over to normal triggering and using the **LEVEL** control can be necessary. With automatic triggering, the trigger point lies approx. in the zero voltage crossing. The time interval, required for the time base start, can be too short at a steep zero crossing of the needle pulse. Then normal triggering should be used.

Automatic triggering is practicable not only with internal but also with external trigger voltage.

Normal Triggering

With normal triggering (**AT/NORM.** button depressed) and **LEVEL** adjustment, the sweep can be started by signals within the frequency range selected by the **TRIG.** coupling switch. **In the absence of an adequate trigger signal or when the trigger controls (particularly the LEVEL control) are misadjusted, no trace is visible, i.e. the screen blanked completely.**

When using the internal normal triggering mode, it is possible to trigger at any amplitude point of a signal edge, even with very complex signal shapes, by adjusting the **LEVEL** control. Its adjusting range is directly dependent on the display height, which should be at least **5mm**. If it is smaller than 1 cm, the **LEVEL** adjustment needs to be operated with a sensitive touch. In the external normal triggering mode, the same applies to approx. 0.6V external trigger voltage amplitude.

Other measures for triggering of very complex signals are the use of the time base variable control and **HOLDOFF** time control, hereinafter mentioned.

Slope

The trigger point can be placed alternatively on a rising or falling edge of the test signal. This is valid with automatic and with normal triggering. The selected slope is set with the **+/-** button. The plus sign (button released) means an

edge, which is coming from a negative potential and rising to a positive potential. That has nothing to do with zero or ground potential and absolute voltage values. The positive slope may also lie in a negative part of a signal. A falling edge (minus sign) triggers, when the **+/-** button is depressed.

However, with normal triggering, the trigger point may be varied within certain limits on the chosen edge using the **LEVEL** control.

Trigger coupling

The coupling mode and accordingly the frequency range of the trigger signal can be changed using the **TRIG.** selector switch. However, this is possible only with the **TV SEP.** switch in **OFF** position.

AC: Trigger range $\geq 10\text{Hz}$ to 20MHz .

This is the most frequently used trigger mode. The trigger threshold is increasing below 10Hz.

DC: Trigger range DC to 20MHz .

DC triggering is recommended, if the signal is to be triggered with quite slow processes or if pulse signals with constantly changing pulse duty factors have to be displayed.

Always work with normal triggering and LEVEL adjustment.

Otherwise there is the possibility in the **AT** position (automatic triggering) that the trigger point may change or that triggering may not occur with signals without zero crossing (e.g. with DC offset). The balance of the corresponding channel input should then be corrected (see "DC Balance Adjustment", page M7). Sometimes triggering is easier with **AC input coupling**, because the signal then has its average value exactly at the oscilloscope's ground potential.

HF: Trigger range 1.5kHz to 40MHz (high-pass filter).

The HF position is suitable for all radio-frequency signals. DC fluctuations and low-frequency excess noise of the trigger voltage are suppressed, giving a stable display. The trigger threshold increases below 1.5kHz.

LF: Trigger range DC to 1kHz (low-pass filter).

The LF position is often more suited for low-frequency signals than the DC position, because the (white) noise in the trigger voltage is strongly suppressed. So jitter or double-triggering of complex signals is avoidable or at least reduced, in particular with very low input voltages. The trigger threshold increases above 1 kHz.

Line triggering

A part of a secondary winding voltage of the power transformer is used as mains/line frequency trigger signal (50 to 60Hz) in the \sim position of the **TRIG.** selector switch. This trigger mode is independent of amplitude and frequency of the Y signal and is recommended for all mains/line synchronous signals. This also applies – within certain limits – to whole number multiples or fractions of the line frequency. Line triggering can also be useful to display signals below the trigger threshold (less than 5 mm). It is therefore particularly suitable for measuring small ripple voltages of mains/line rectifiers or stray magnetic field in a circuit.

Magnetic leakage (e.g. from a power transformer) can be investigated for direction and amplitude using a search or pick-up coil. The coil should be wound on a small former with a maximum of turns of a thin lacquered wire and connected to a BNC connector (for scope input) via a shielded cable. Between cable and BNC center conductor a resistor of at least 100Ω should be series-connected (RF decoupling). Often it is advisable to shield statically the surface of the coil. However, no shorted turns are permissible. Maximum, minimum, and direction to the magnetic source are detectable at the measuring point by turning and shifting the coil.

Triggering of video signals

The built-in active **TV-Sync-Separator** (separation of the sync pulses from the video signal and following amplification) even allows the display of noisy, changing in amplitude or distorted video signals, alternatively triggered with line (or horizontal) frequency or frame (or vertical) frequency. The **TV SEP.** lever switch has three positions. The **OFF** position serves to all normal operations; the **TRIG.** selector switch is operative. The **TV: H** position (horizontal \triangleq line) and the **TV: V** position (vertical \triangleq frame) are used for video triggering. The **TRIG.** coupling switch is inoperable in these both positions. In the **TV: V** position (frame triggering), a low-pass filter or integrating network is connected into circuit, which forms a trigger pulse sequence with frame frequency from the vertical sync pulse (incl. pre- and post-equalizing pulses).

For accurate function of the sync separator, the slope of the sync pulses should correctly be adjusted (corresponding to the position of the sync pulses in the composite color signal. If the sync pulses are placed above the picture content, the **+/-** button should be released. The trigger point lies on the rising front edge of the sync pulse. If they are below the picture content, the **+/-** button should be depressed. The trigger point lies on a falling (negative) front edge of the sync pulse. This setting of the slope is valid for line and frame frequency. An incorrectly set slope results in an unstable dis-

play. The trigger slope cannot be changed using the **INVERT** buttons. The **+/-** button relates always to the input signal! Video signals are triggered in the automatic mode. Therefore the adjustment of the trigger point with **LEVEL** knob is superfluous. The internal triggering is virtually independent of the display height, which may differ from 0.8 to 8 cm. Depressing the **AT/NORM.** button results in the difference (opposite to **AT**) that the screen is blanked without trigger signal (turning the **LEVEL** knob is ineffectual).

Aside from the **TV SEP.** switch and the **+/-** button setting, a time coefficient, adequate to the measuring purpose, should be selected on the **TIME/DIV.** switch. The basic positions for **H** (horizontal \triangleq line) and **V** (vertical \triangleq frame) are marked on the scale of the **TIME/DIV.** switch. However, the **TIME/DIV.** knob may be turned more to the right (without break down of the triggering), if more details in the video signal should be required. More advantageous, because one video field is suppressed, is the use of the 10-fold expansion with the **X-MAG. x10** button and the **HOLD-OFF** time setting. Disconnecting the trigger circuit (e.g. by rapidly pressing and releasing the **EXT.** button) can result in triggering the consecutive (odd or even) field.

Setting: **TV: V, 2 ms/cm, HOLDOFF** knob at the right stop, **X-MAG. x10** button depressed, searching the picture detail with **X-POS.** knob, additional X-expansion (x2.5) with time variable knob fully cw. So the International Insertion Test Signals including Video Text and VPS etc. in the vertical blanking interval are fully visible with a 25:1 expansion ratio.

The sync-separator-circuit also operates with external triggering. It is important that the voltage range ($0.3V_{pp}$ to $6V_{pp}$) for external triggering should be noted. In addition, the correct slope setting is again critical, because the external trigger signal may not have the same polarity or pulse edge as the test signal. This can be checked, if the external trigger voltage itself is displayed at first (with internal triggering).

Generally, the composite video signal has a high DC content. With a constant video information (e.g. test pattern or color bar generator), the DC content can be suppressed easily by **AC** input coupling of the oscilloscope amplifier. With a changing picture content (e.g. normal program), **DC** input coupling is recommended, because the display varies its height on screen with **AC** input coupling at each change of the picture content. The DC content can be compensated using the **Y-POS.** control so that the signal display lies in the graticule area. Then the composite video signal should not exceed a vertical height of 6 cm.

External triggering

The internal triggering is disconnected by depressing the **EXT.** button. The timebase can be triggered *externally* via

the **TRIG. INP.** socket using a $0.25V_{pp}$ to $5V_{pp}$ voltage, which is in synchronism with the test signal. This trigger voltage may have completely different form from the test signal voltage. Triggering is even possible – in certain limits – with whole number multiples or fractions of the test frequency, but only in locked phase relation.

The input impedance of **TRIG. INP.** socket is approx. $0.8M\Omega \parallel 30pF$. The maximum input voltage of the input circuit is 100V (DC + peak AC). Only $5V_{pp}$ maximum are required for a good external triggering.

Trigger indicator

An LED on condition (to the left of the **TRIG.** switch) indicates that the sweep generator is triggered. This is valid with automatic and with normal triggering. The indication of trigger action facilitates a sensitive **LEVEL** adjustment, particularly at very low signal frequencies. The indication pulses are of only 100ms duration.

Thus for fast signals the LED appears to glow continuously, for low repetition rate signals, the LED flashes at the repetition rate or – at a display of several signal periods – not only at the start of the sweep at the left screen edge, but also at each signal period.

Holdoff-time adjustment

If it is found that a trigger point cannot be located on extremely complex signals even after repeated and careful adjustment of the **LEVEL** control in the *normal triggering* mode, a stable display may be obtained using the **HOLD-OFF** control (in the X-field). This facility varies the hold-off time between two sweep periods approx. up to the ratio 10:1. Pulses or other signal waveforms appearing during this off period cannot trigger the timebase. Particularly with burst signals or aperiodic pulse trains of the same amplitude, the start of the sweep can be delayed until the optimum or required moment.

A very noisy signal or a signal with a higher interfering frequency is at times double displayed. It is possible that LEVEL adjustment only controls the mutual phase shift, but not the double display. The stable single display of the signal, required for the evaluation, is easily obtainable by expanding the holdoff time. To this end the HOLDOFF knob is slowly turned to the right, until one signal is displayed.

A double display is possible with certain pulse signals, where the pulses alternately show a small difference of the peak amplitudes. Only a very exact **LEVEL** adjustment makes a single display possible. The use of the **HOLD-OFF** knob simplifies the right adjustment.

After specific use the **HOLD-OFF** control should be re-set into its calibration detent, otherwise the brightness of the display is reduced drastically. The function is shown in the following figures.

Function of var. HOLD-OFF control

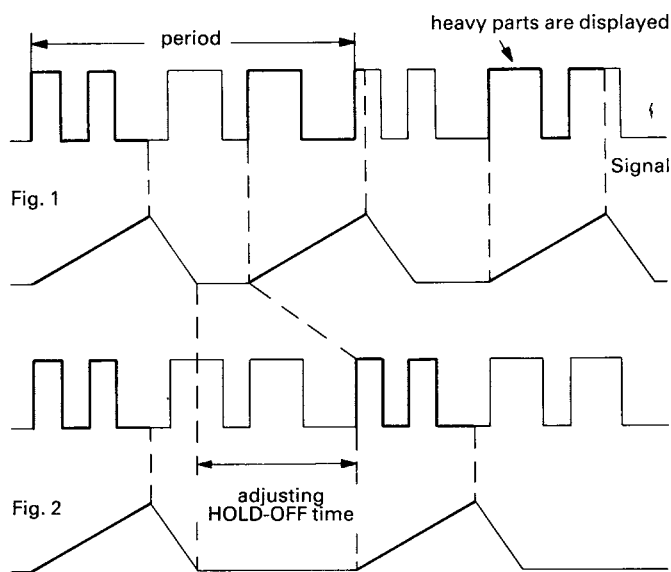

Fig. 1 shows a case where the **HOLD-OFF** knob is in the minimum position and various different waveforms are overlapped on the screen, making the signal observation unsuccessful.

Fig. 2 shows a case where only the desired parts of the signal are stably displayed.

Component Tester

General

The HM203-6 has a built-in electronic Component Tester (abbreviated **CT**), which is used for instant display of a test pattern to indicate whether or not components are faulty. The **CT** can be used for quick checks of semiconductors (e.g. diodes and transistors), resistors, capacitors, and inductors. Certain tests can also be made to integrated circuits. All these components can be tested in and out of circuit.

The test principle is fascinatingly simple. The power transformer of the oscilloscope delivers a sine voltage, which is applied across the component under test and a built-in fixed resistor. The sine voltage across the test object is used for the horizontal deflection, and the voltage drop across the resistor (i.e. current through test object) is used for vertical deflection of the oscilloscope. The test pattern shows a current-voltage characteristic of the test object.

Since this circuit operates with mains/line frequency (50 or 60 Hz) and a voltage of 8.5 V max. (open circuit), the indicating range of the **CT** is limited. The impedance of the component under test is limited to a range from 20 Ω to 4.7 k Ω . Below and above these values, the test pattern shows only short-circuit or open-circuit. For the interpretation of the displayed test pattern, these limits should always be borne in mind. However, most electronic components can normally be tested without any restriction.

Using the Component Tester

The **CT** is switched on by depressing the **CT** pushbutton beneath the screen. This makes the vertical preamplifier and the timebase generator inoperative. A shortened horizontal trace will be observed. It is not necessary to disconnect scope input cables unless in-circuit measurements are to be carried out. In the **CT** mode, the only controls which can be operated are **INTENS.**, **FOCUS**, and **X-POS.**. All other controls and settings have no influence on the test operation.

For the component connection, two simple test leads with 4 mm \varnothing banana plugs, and with test prod, alligator clip or sprung hook, are required. The test leads are connected to the insulated **CT** socket and the adjacent ground socket in the Y-Section. The component can be connected to the test leads either way round.

After use, to return the oscilloscope to normal operation, release the **CT** pushbutton.

Test Procedure

Caution! Do not test any component in live circuitry – remove all grounds, power and signals connected to the component under test. Set up Component Tester as stated above. Connect test leads across component to be tested. Observe oscilloscope display.

Only discharged capacitors should be tested!

A built-in quick-acting fuse protects the **CT** and the oscilloscope against mis-operation, e.g. device under test not disconnected from mains/line supply. In that case the fuse will blow. For fuse replacement the oscilloscope has to be opened (see service instruction page S1 "Instrument Case Removal"). The fuse is located on the bottom side of the instrument (close to the **CT** pushbutton). Make sure that only fuses of the specified type are used for replacement: **5x20mm, quick-acting, 250V, C, 50mA** (IEC 127/II or DIN 41661).

Test Pattern Displays

Page M17 shows typical test patterns displayed by the various components under test.

- **Open circuit is indicated by a straight horizontal line.**
- **Short circuit is shown by a straight vertical line.**

Testing Resistors

If the test object has a linear ohmic resistance, both deflecting voltages are in the same phase. The test pattern expected from a resistor is therefore a sloping straight line. The angle of slope is determined by the resistance of the resistor under test. With high values of resistance, the slope will tend towards the horizontal axis, and with low values, the slope will move towards the vertical axis.

Values of resistance from 20Ω to $4.7k\Omega$ can be approximately evaluated. The determination of actual values will come with experience, or by direct comparison with a component of a known value.

Testing Capacitors and Inductors

Capacitors and inductors cause a phase difference between current and voltage, and therefore between the X and Y deflection, giving an ellipse-shaped display. The position and opening width of the ellipse will vary according to the impedance value (at 50 or 60Hz) of the component under test.

A horizontal ellipse indicates a high impedance or a relatively small capacitance or a relatively high inductance.

A vertical ellipse indicates a small impedance or a relatively large capacitance or a relatively small inductance.

A sloping ellipse means that the component has a considerable ohmic resistance in addition to its reactance.

The values of capacitance of normal or electrolytic capacitors from $0.1\mu F$ to $1000\mu F$ can be displayed and approximate values obtained. More precise measurement can be obtained in a smaller range by comparing the capacitor under test with a capacitor of known value. Inductive components (coils, transformers) can also be tested. The determination of the value of inductance needs some experience, because inductors have usually a higher ohmic series resistance. However, the impedance value (at 50 or 60Hz) of an inductor in the range from 20Ω to $4.7k\Omega$ can easily be obtained or compared.

Testing Semiconductors

Most semiconductor devices, such as diodes, Z-diodes, transistors, FETs can be tested. The test pattern displays vary according to the component type as shown in the figures below.

The main characteristic displayed during semiconductor testing is the voltage dependent knee caused by the junction changing from the conducting state to the non conducting state. It should be noted that both the forward and the reverse characteristic are displayed simultaneously. This is a two-terminal test, therefore testing of transistor amplification is not possible, but testing of a single junction is easily and quickly possible. Since the **CT** test voltage applied is only very low (max. $8.5V_{rms}$), all sections of most semiconductors can be tested without damage. However, checking the breakdown or reverse voltage of high voltage semiconductors is not possible. More important is testing components for open or short-circuit, which from experience is most frequently needed.

Testing Diodes

Diodes normally show at least their knee in the forward characteristic. This is not valid for some high voltage diode types, because they contain a series connection of several diodes. Possibly only a small portion of the knee is visible. Z-diodes always show their forward knee and, up to approx. 10V, their Z-breakdown, forms a second knee in the opposite direction. A Z-breakdown voltage of more than 12V can not be displayed.



Type:	Normal Diode	High Voltage Diode	Z-Diode 12V
Terminals:	Cathode-Anode	Cathode-Anode	Cathode-Anode
Connections:	(CT-GD)	(CT-GD)	(CT-GD)

The polarity of an unknown diode can be identified by comparison with a known diode.

Testing Transistors

Three different tests can be made to transistors: base-emitter, base-collector and emitter-collector. The resulting test patterns are shown below.

The basic equivalent circuit of a transistor is a Z-diode between base and emitter and a normal diode with reverse polarity between base and collector in series connection. There are three different test patterns:

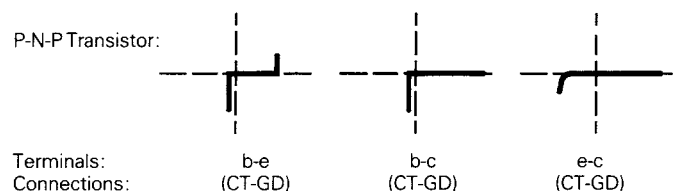
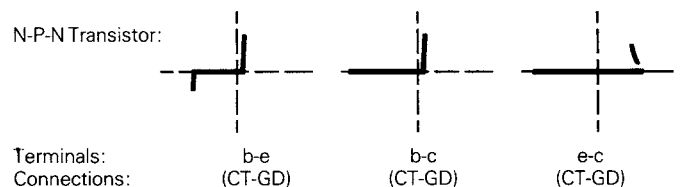

For a transistor the figures b-e and b-c are important. The figure e-c can vary; but a vertical line only shows short circuit condition.

These transistor test patterns are valid in most cases, but there are exceptions to the rule (e.g. Darlington, FETs). With the **CT**, the distinction between a P-N-P to a N-P-N transistor is discernible. In case of doubt, comparison with a known type is helpful. It should be noted that the same socket connection (**CT** or ground) for the same terminal is then absolutely necessary. A connection inversion effects a rotation of the test pattern by 180 degrees round about the center point of the scope graticule.

Pay attention to the usual caution with single MOS-components relating to static charge or frictional electricity!

In-Circuit Tests

Caution! During in-circuit tests make sure the circuit is dead. No power from mains/line or battery and no signal inputs are permitted. Remove all ground connections including Safety Earth (pull out power plug from outlet). Remove all measuring cables including probes

between oscilloscope and circuit under test. Otherwise both CT test leads are not isolated against the circuit under test.

In-circuit tests are possible in many cases. However, they are not so well-defined. This is caused by a shunt connection of real or complex impedances – especially if they are of relatively low impedance at 50 or 60Hz – to the component under test, often results differ greatly when compared with single components. In case of doubt, one component terminal may be unsoldered. This terminal should then be connected to the insulated **CT** socket avoiding hum distortion of the test pattern.

Another way is a test pattern comparison to an identical circuit which is known to be operational (likewise without power and any external connections). Using the test prods, identical test points in each circuit can be checked, and a defect can be determined quickly and easily. Possibly the device itself under test contains a reference circuit (e.g. a second stereo channel, push-pull amplifier, symmetrical bridge circuit), which is not defective.

The test patterns on page M17 show some typical displays for in-circuit tests.

Single Components



Short circuit

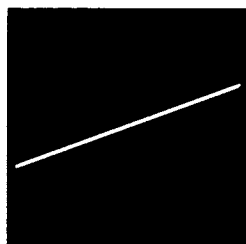

Resistor 510Ω



Mains transformer prim.

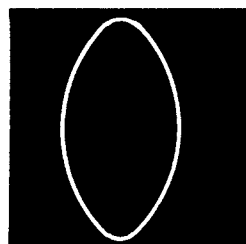

Capacitor 33μF

Single Transistors

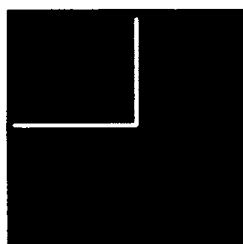

Junction B-C

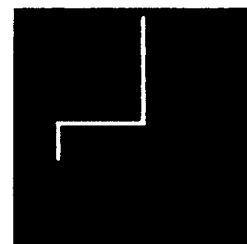

Junction B-E

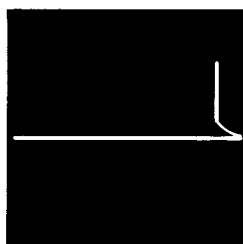

Junction E-C



FET

Single Diodes

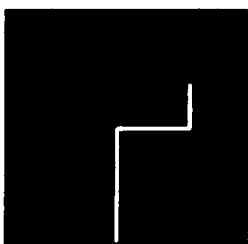

Z-diode under 8V

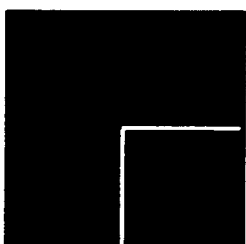

Z-diode beyond 12V

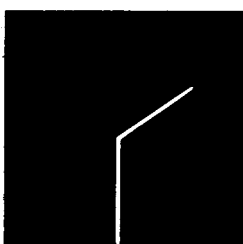

Diode paralleled by 680Ω

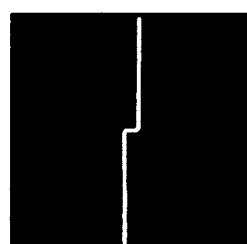

2 Diodes antiparallel

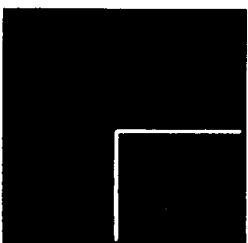

Silicon diode

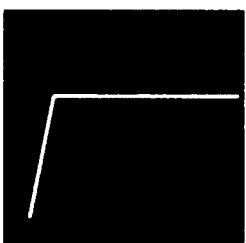

Germanium diode

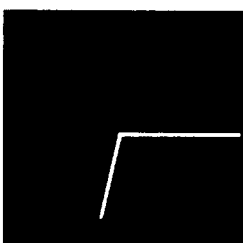

Diode in series with 51Ω



B-E paralleled by 680Ω

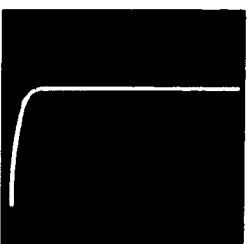

Rectifier

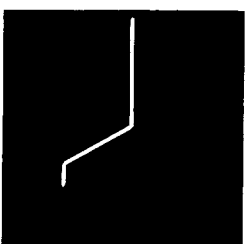

Thyristor G + A together

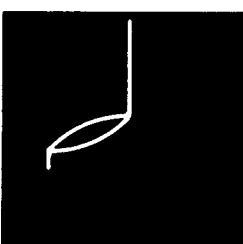

B-E with 1μF + 680Ω



Si-diode with 10μF

In-circuit Semiconductors

Switching on and initial setting

Connect instrument to power outlet, depress red **POWER** button. LED indicates operating condition.

Case, chassis and all measuring terminals are connected to the safety earth conductor (Safety Class I).

Do not depress any further button. **TRIG.** selector switch to **AC**, **TV SEP.** switch to **OFF**.

AT/NORM. button released, **CH. I** input coupling switch to **GD**, set **TIME/DIV.** switch to **50 μs/cm**.

Adjust **INTENS.** control for average brightness.

Center trace on screen using **X-POS.** and **Y-POS. I** controls. Then focus trace using **FOCUS** control.

Vertical amplifier mode

Channel I: All buttons in the Y section in out position.

Channel II: **CH I/II** button depressed.

Channel I and II: **DUAL** button depressed. Alternate channel switching: **CHOP.** (**ADD**) button in out position.

Signals < 1 kHz or time coefficient ≥ 1 ms/cm: **DUAL** and **CHOP.** buttons depressed.

Channel I+II or -I -II (sum): depress only **ADD** button.

Channel -I +II or I -II (difference): depress **ADD** and **one** of the **INVERT** buttons.

Triggering mode

Select trigger mode with **AT/NORM.** button:

AT = Automatic Triggering ≥ 10 Hz to 20 MHz (out position). **NORM. = Normal Triggering** (depressed).

Trigger edge direction: select slope with **+/-** button.

Internal triggering: select channel with **TRIG. I/II(CH. I/II)** button.

External triggering: **EXT.** button depressed; sync signal ($0.3V_{pp}$ to $6V_{pp}$) to **TRIG. INP.** socket.

Line triggering: **TRIG.** selector switch to \sim .

Select trigger coupling with **TRIG.** selector switch. Trigger frequency ranges:

AC: ≥ 10 Hz to 20 MHz; **DC:** DC to 20 MHz; **HF:** 1.5 kHz to 40 MHz; **LF:** DC to 1 kHz.

Composite video signal with line or horizontal frequency: **TV SEP.** switch to **TV: H.**

Composite video signal with frame or vertical frequency: **TV SEP.** switch to **TV: V.**

Select edge direction with **+/-** button (sync. pulse above $\triangle +$, below $\triangle -$).

Pay attention to trigger indicator: LED near to **TRIG.** selector switch.

Measurements

Apply test signal to the vertical input connectors of **CH. I** and/or **CH. II**.

Before use, calibrate attenuator probe with built-in square wave generator **CAL.**

Switch input coupling to **AC** or **DC**.

Adjust signal to desired display height with attenuator switch.

Select time coefficient on the **TIME/DIV.** switch.

Set trigger point with **LEVEL** knob for Normal Triggering.

Trigger complex or aperiodic signals with longer **HOLD-OFF**-time.

Amplitude measurement with Y fine control at left stop (**CAL.**).

Time measurement with time fine control at left stop (**CAL.**).

Horizontal expansion x10 with **X-MAG. x10** button depressed.

External horizontal sweep (**X-Y mode**) with **X-Y** button depressed (X input: **CH. II**).

Component Tester

Press **COMPONENT TESTER** button. Connect both component terminals to **CT** and ground jacks.

In-circuit test: Circuit under test must be disconnected from battery or power (pull out power plug), signals and ground (earth). Remove all signal connections to **HM203-6** (cable, probe), then start testing.

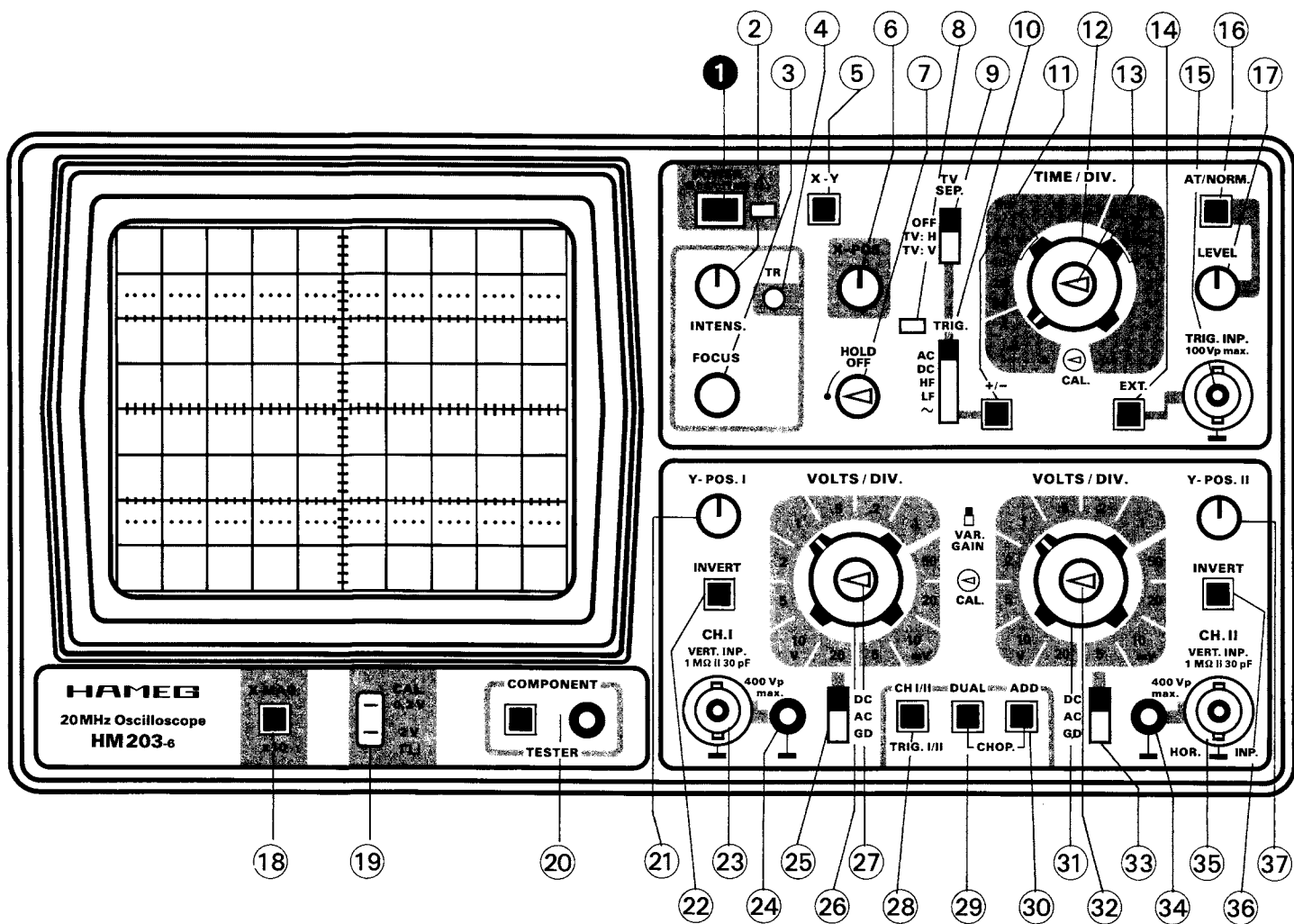

Front Panel Elements HM203-6 (Brief Description – Front View)

Element	Function	Element	Function
① POWER on/off (pushbutton + LED)	Turns scope on and off. LED indicates operating condition.	②③ CH. I (BNC connector)	CH. I signal input. Input impedance 1MΩ 30pF.
② INTENS. (knob)	Intensity control for trace brightness.	②④ Ground (4mm socket)	Separate ground jack.
③ FOCUS (knob)	Focus control for trace sharpness.	②⑤ DC-AC-GD (slide switch)	Selects input coupling of the CH. I Vertical Amplifier. DC: All components of the input signal are passed. AC: Signal is capacitively coupled (DC is blocked). GD: Signal is disconnected, amplifier input is grounded.
④ TR (pot)	Trace rotation. To align trace with horizontal graticule line. Compensates influence of earth's magnetic field.	②⑥ VOLTS/DIV. (rotary switch)	CH. I input attenuator. Selects input sensitivity in mV/cm or V/cm in 1-2-5 sequence.
⑤ X-Y (pushbutton switch)	Selects X-Y operation, stops sweep. X signal via CH. II. Attention! Phosphor burn-in without X signal.	②⑦ VAR. GAIN (center knob)	Continuously variable gain between the calibrated settings of the VOLTS/DIV switch. Increases sensitivity 2.5 : 1. Cal. position: ccw.
⑥ X-POS. (knob)	Controls horizontal position of trace.	②⑧ CH I/II-TRIG. I/II (pushbutton switch)	Button released: CH. I only and internal trig. from CH. I. Button depressed: CH. II only and internal trig. from CH. II. In DUAL and ADD mode: Button selects internal trigger signal.
⑦ HOLD OFF (knob)	Controls holdoff-time between sweeps. Normal position = full ccw.	②⑨ DUAL (pushbutton switch)	<div style="display: flex; align-items: center;"> <div style="margin-right: 10px;"> <p>②⑨ DUAL (pushbutton switch)</p> </div> <div style="margin-right: 10px;"> <p>③① ADD (pushbutton switch)</p> </div> <div style="margin-right: 10px;"> <p>CHOP.</p> </div> </div> <p>Button released: One channel only. Button depressed: CH. I and CH. II in alternate mode. DUAL and ADD buttons depressed: CH. I and CH. II in chopped mode.</p>
⑧ TRIG. (LED)	LED lights, if sweep is triggered.	③① ADD (pushbutton switch)	
⑨ TV SEP. (lever switch)	TV-Sync-Separator. OFF = Normal operation. TV: H = Line or horizontal frequency. TV: V = Frame or vertical frequency.	③② VOLTS/DIV. (rotary switch)	CH. II input attenuator. Selects input sensitivity in mV/cm or V/cm in 1-2-5 sequence.
⑩ TRIG. AC-DC-HF-LF-~ (lever switch)	Trigger selector AC: 10 Hz to 20 MHz. DC: DC to 20 MHz. HF: 1.5 kHz to 40 MHz. LF: DC to 1 kHz. ~: Internal line triggering.	③③ VAR. GAIN (center knob)	Continuously variable gain between the calibrated settings of the VOLTS/DIV switch. Increases sensitivity 2.5 : 1. Cal. position: ccw.
⑪ +/- (pushbutton switch)	Selects the slope of the trigger signal. + = rising edge; - = falling edge.	③④ DC-AC-GD (slide switch)	Selects input coupling of the CH. II Vertical Amplifier. DC: All components of the input signal are passed. AC: Signal is capacitively coupled (DC is blocked). GD: Signal is disconnected, amplifier input is grounded.
⑫ TIME/DIV. (rotary switch)	Selects timebase speeds from 0.5 μs/cm to 0.2 s/cm.	③④ Ground (4mm socket)	Separate ground jack.
⑬ Variable (center knob)	Timebase variable control. Increases timebase sweep speed 2.5 : 1 Cal. position = full counterclockwise.	③⑤ CH. II BNC connector)	CH. II signal input. Input impedance 1MΩ 30pF.
⑭ EXT. (pushbutton switch)	Button released = internal triggering. Button depressed = external triggering, trigger signal via TRIG. INP. ⑮.	③⑥ INVERT (CH II) (pushbutton switch)	Inversion of CH. II display. In combination with ADD button ③① = algebraic addition. In X-Y mode inoperative.
⑮ TRIG. INP. (BNC connector)	Input for external trigger signal, if button ⑭ is depressed.	③⑦ Y-POS. II (knob)	Controls vertical position of CH. II display. In X-Y mode inoperative.
⑯ AT/NORM. (pushbutton switch)	Button released = autom. triggering, trace visible without input signal. Button depressed = normal triggering with LEVEL ⑰ adjustment, trace invisible without signal.		
⑰ LEVEL (knob)	To adjust trigger point, if AT/NORM. ⑯ button is depressed.		
⑱ X-MAG. x10 (pushbutton switch)	10 : 1 expansion in the X direction. Resolution (incl. ⑬) 20 ns/cm.		
⑲ CALIBRATOR 0.2V-2V (4,9 mm sockets)	Calibrator output sockets for probes 10 : 1 = 0.2 V _{pp} , 100 : 1 = 2 V _{pp} (□).		
⑳ COMPONENT TESTER (pushbutton switch and 4 mm jack)	Button depressed: CT in operation. 2-terminal measurement: component connection to CT jack and ground jack.		
㉑ Y-POS. I (knob)	Controls vertical position of CH. I display.		
㉒ INVERT (CH I) (pushbutton switch)	Inversion of CH. I display. In combination with ADD button ③① = algebraic addition.		

Controls located underneath the instrument:

CH. I DC-Balance **CH. II** Correction of DC balance.
(pots) Adjustment with screwdriver.

Test Instructions

General

These Test Instructions are intended as an aid for checking the most important characteristics of the HM 203-6 at regular intervals without the need for expensive test equipment. Resulting corrections and readjustments inside the instrument, indicated by the following tests, are described in the Service Instructions or on the Adjusting Plan. They should only be undertaken by qualified personnel.

As with the First Time Operation instructions, care should be taken that all knobs with arrows are set to their calibrated positions. None of the pushbuttons should be depressed. **TRIG.** selector switch to **AC**, **TV SEP.** switch to **OFF**. It is recommended to switch on the instrument for about 15 minutes prior to the commencement of any check.

Cathode-Ray Tube: Brightness and Focus, Linearity, Raster Distortions

Normally, the CRT of the HM203-6 has very good brightness. Any reduction of this brightness can only be judged visually. However, decreased brightness may be the result of wrong setting or reduced high voltage. The latter is easily recognized by the greatly increased sensitivity of the vertical amplifier. Wrong setting means, that the controls **HOLDOFF** and **timebase variable** should be turned to the left stop; the **X-MAG. x10** button should be released; a medium time coefficient should be selected; line triggering (\sim position) should be used only with a suitable **TIME/DIV.** switch setting (e.g. **2ms/cm**). The control range for maximum and minimum brightness (intensity) must be such that the beam just disappears before reaching the left hand stop of the **INTENS.** control (particularly when the **X-Y** button is depressed), while with the control at the right hand stop the focus and the line width are just acceptable.

With maximum intensity the timebase fly-back must on no account be visible. Visible trace fault without input signal: bright dot on the left side — **or** — decreasing brightness from left to right or shortening of the baseline. (Cause: Incorrect Unblanking Pulse.) It should be noted that with wide variations in brightness, refocusing is always necessary. Moreover, with maximum brightness, no “pumping” of the display must occur. If pumping does occur, it is normally due to a fault in the regulation circuitry for the high voltage supply. The presetting pots for the high voltage circuit, minimum and maximum intensity, are only accessible inside the instrument (see Adjusting Plan and Service Instructions).

A certain out-of-focus condition in the edge zone of the screen must be accepted. It is limited by standards of the CRT manufacturer. The same is valid for tolerances of the orthogonality, the undeflected spot position, the non-linearity and the raster distortion in the marginal zone of the

screen in accordance with international standards (see CRT data book). These limit values are strictly supervised by HAMEG. The selection of a cathode-ray tube without any tolerances is practically impossible.

Astigmatism Check

Check whether the horizontal and vertical sharpness of the display are equal. This is best seen by displaying a square-wave signal with the repetition rate of approximately 1 MHz. Focus the horizontal tops of the square-wave signal at normal intensity, then check the sharpness of the vertical edges. If it is possible to improve this vertical sharpness by turning the **FOCUS** control, then an adjustment of the astigmatism control is necessary. A potentiometer of 50k Ω (see Adjusting Plan) is provided inside the instrument for the correction of astigmatism (see Service Instructions). A certain loss of marginal sharpness of the CRT is unavoidable; this is due to the manufacturing process of the CRT.

Symmetry and Drift of the Vertical Amplifier

Both of these characteristics are substantially determined by the input stages of the amplifiers. **The checking and correction of the DC balance for the amplifiers should be carried out as already described in the Operating Instructions** (page M8).

The symmetry of both channels and the vertical final amplifier can be checked by inverting Channel I and II (depress the corresponding **INVERT** pushbutton). The vertical position of the trace should not change by more than 5 mm. However, a change of 1 cm is just permissible. Larger deviations indicate that changes have occurred in the amplifier. A further check of the vertical amplifier symmetry is possible by checking the control range of the **Y-POS.** controls. A sine-wave signal of 10-100kHz is applied to the amplifier input. When the **Y-POS.** control is then turned fully in both directions, from stop to stop with a display height of approximately **8cm**, the upper and lower positions of the trace that are visible should be approximately of the same height. Differences of up to 1cm are permissible (input coupling should be set to **AC**).

Checking the drift is relatively simple. **Ten minutes after switching on the instrument**, set the baseline exactly on the horizontal center line of the graticule. The beam position must not change by more than **5mm** during the following hour. Larger deviations generally result from different characteristics of the dual FETs in both channel inputs to the Y amplifier. To some extent, fluctuations in drift are caused by offset current on the gate. The drift is too high, if the vertical trace position drifts by more than **0.5mm** on turning the appropriate attenuator switch through all 12 steps. Sometimes such effects occur after long periods of operation.

Calibration of the Vertical Amplifier

Two square-wave voltages of $0.2V_{pp}$ and $2V_{pp} \pm 1\%$ are present at the output eyelets of the calibrator (**CAL.**). If a direct connection is made between the **0.2V** output and the input of the vertical amplifier (e.g. using a **x1 probe**), the displayed signal in the **50mV/cm** position (variable control to **CAL.**) should be **4cm** high (**DC** input coupling). Maximum deviations of 1.2mm (3%) are permissible. If a **X10 probe** is connected between the **2V** output and Y input, the same display height should result. With higher tolerances it should first be investigated whether the cause lies, within the amplifier or in the amplitude of the square-wave signal. On occasions it is possible that the probe is faulty or incorrectly compensated. If necessary the measuring amplifier can be calibrated with an accurately known DC voltage (**DC** input coupling). The trace position should then vary in accordance with the deflection coefficient set.

With variable control at the attenuator switch fully clockwise, the input sensitivity is increased at least by the factor 2.5 in each position. In the **100mV/cm** position, the displayed calibrator signal height should vary from 2cm to at least 5cm.

Transmission Performance of the Vertical Amplifier

The transient response and the delay distortion correction can only be checked with the aid of a square-wave generator with a fast risetime (**max. 5ns**). The signal coaxial cable (e.g. HZ34) must be terminated at the vertical input of the oscilloscope with a resistor equal to the characteristic impedance of the cable (e.g. with HZ22). Checks should be made at 100Hz, 1kHz, 10kHz, 100kHz and 1MHz, the deflection coefficient should be set at **5mV/cm** with **DC** input coupling (Y variable control in **CAL.** position). In so doing, the square pulses must have a flat top without ramp-off, spikes and glitches; no overshoot is permitted, especially at 1MHz and a display height of **4-5cm**. At the same time, the leading top corner of the pulse must not be rounded. In general, no great changes occur after the instrument has left the factory, and it is left to the operator's discretion whether this test is undertaken or not. A suited generator for this test is HZ60 from HAMEG.

Of course, the quality of the transmission performance is not only dependent on the vertical amplifier. **The input attenuators**, located in the front of the amplifier, **are frequency-compensated in each position**. Even small capacitive changes can reduce the transmission performance. Faults of this kind are as a rule most easily detected with a square-wave signal with a low repetition rate (e.g. 1kHz). If a suitable generator with max. output of $40V_{pp}$ is available, it is advisable to check at regular intervals the deflection coefficients on all positions of the input attenuators and readjust them as necessary. A compensated **2:1 series attenuator**

(e.g. HZ23) is also necessary, and this must be matched to the input impedance of the oscilloscope. This attenuator can be made up locally. It is important that this attenuator is shielded. For local manufacture, the electrical components required are a $1M\Omega \pm 1\%$ resistor and, in parallel with it, a trimmer 3-15pF in parallel with approx. 20pF. One side of this parallel circuit is connected directly to the input connector of CH.I or CH.II and the other side is connected to the generator, if possible via a low-capacitance coaxial cable. The series attenuator must be matched to the input impedance of the oscilloscope in the **5mV/cm** position (variable control to **CAL.**, **DC** input coupling; square tops exactly horizontal; no ramp-off is permitted). This is achieved by adjusting the trimmer located in the 2:1 attenuator. **The shape of the square-wave should then be the same in each input attenuator position.**

Operating Modes: CH.I/II, DUAL, ADD, CHOP., INVERT and X-Y Operation

On depressing the **DUAL** pushbutton, two traces must appear immediately. On actuation of the **Y-POS.** controls, the trace positions should have no effect on each other. Nevertheless, this cannot be entirely avoided, even in fully serviceable instruments. When one trace is shifted vertically across the entire screen, the position of the other trace must not vary by more than 0.5mm.

A criterion in chopped operation is trace widening and shadowing around and within the two traces in the upper or lower region of the screen. Set **TIME/DIV.** switch to **2 μ s/cm**, depress the **DUAL** and **CHOP.** pushbutton, set input coupling of both channels to **GD** and advance the **INTENS.** control fully clockwise. Adjust **FOCUS** for a sharp display. With the **Y-POS.** controls shift one of the traces to a +2cm, the other to a -2cm vertical position from the horizontal center line of the graticule. Do not try to synchronize (with the time variable control) the chop frequency (0.5MHz)! Then alternately release and depress the **CHOP.** pushbutton. Check for negligible trace widening and periodic shadowing in the chopped mode.

It is important to note that in the **I+II** or **-I-II** add mode (only **ADD** depressed) or the **-I+II** or **+I-II** difference mode (specific **INVERT** buttons depressed in addition) the vertical position of the trace can be adjusted by using **both** the Channel I and Channel II **Y-POS.** controls.

In X-Y Operation (**X-Y** pushbutton depressed), the sensitivity in both deflection directions will be the same. When the signal from the built-in square-wave generator is applied to the input of Channel II, then, as with Channel I in the vertical direction, there must be a horizontal deflection of **4cm** when the deflection coefficient is set to **50mV/cm** position (variable control set to its **CAL.** position, **X-MAG. x10** button in out position). The check of the mono channel display with the **CHI/II** button is unnecessary; it is contained indirectly in the tests above stated.

Triggering Checks

The internal trigger threshold is important as it determines the display height from which a signal will be stably displayed. It should be approx. 3-5mm for the HM203-6. An increased trigger sensitivity creates the risk of response to the noise level in the trigger circuit, especially when the sensitivity of the vertical input is increased by turning the variable control fully clockwise. This can produce double-triggering with two out-of-phase traces. Alteration of the trigger threshold is only possible internally. Checks can be made with any **sine-wave voltage** between 50Hz and 1 MHz. The **AT/NORM.** button should be in out position (**Automatic Triggering**). Following this it should be ascertained whether the same trigger sensitivity is also present with Normal Triggering (**AT/NORM.** button depressed). In this trigger mode, a **LEVEL** adjustment is necessary. The checks should show the same trigger threshold with the same frequency. On depressing the **+/-** slope button, the start of the sweep changes from the positive-going to the negative-going edge of the trigger signal. As described in the Operating Instructions, the trigger frequency range is dependent on the trigger coupling selected. For higher frequencies the **HF** coupling mode must be selected. In this mode, triggering up to at least 40MHz (sine-wave) is possible. Internally the HM203-6 should trigger perfectly at a display height of approx. 5mm, when the appropriate trigger coupling mode is set.

For external triggering (**EXT.** button depressed), the **EXT. TRIG.** input connector requires a signal voltage of at least **0.25 V_{pp}**, which is in synchronism with the Y input signal. The voltage value is dependent on the frequency and the trigger coupling mode (**AC-DC-HF-LF**).

Checking of the TV triggering is possible with a video signal of any given polarity. Use the **TV: H** position of the **TV SEP.** switch for triggering on **line** or horizontal frequency (**TIME/DIV.** switch to 20 or 10 μ s/cm). The **TV: V** position is required for **frame** or vertical frequency (**TIME/DIV.** switch to 5 or 2ms/cm). With the **+/-** button the correct slope of the line sync pulse (front edge) must be selected. This slope is then valid for both sync frequencies.

Perfect TV triggering is achieved, when in both display modes the amplitude of the complete TV signal (from white level to the top of the line sync pulse) is limited between 0.8 and 8cm.

The display should not shift horizontally during a change of the trigger coupling from **AC** to **DC** with a **sine-wave signal without DC offset**. The basic requirement for this is a correct **DC Balance Adjustment** on the input of the vertical amplifier (see Operating Instructions, page M8).

If both vertical inputs are **AC** coupled to the same signal and both traces are brought to coincide exactly on the screen,

when working in the **alternate dual channel mode**, then no change in display should be noticeable, when the **CH.I/II-TRIG.I/II** button is depressed or released or when the **TRIG.** selector switch is changed from **AC** to **DC** position.

Checking of the line/mains frequency triggering (50-60Hz) is possible, when the input signal is time-related (multiple or submultiple) to the power line frequency (**TRIG.** selector switch to \sim). There is no trigger threshold in this trigger mode. Even very small input signals are triggered stably (e.g. ripple voltage). For this check, use an input of approx. 1V. The displayed signal height can then be varied by turning the respective input attenuator switch and its variable control.

Timebase

Before checking the timebase it should be ascertained that the **trace length is 10.1 cm in all time ranges**. If not, it can be corrected with the potentiometer for sweep amplitude (see Adjusting Plan). This adjustment should be made with the **TIME/DIV.** switch in a mid position (i.e. **5 μ s/cm**). Prior to the commencement of any check set the time variable control to **CAL**. The **X-MAG. x10** button should be in out position. This condition should be maintained until the variation ranges of these controls are checked.

Check that the **sweep runs from the left to the right side of the screen** (**TIME/DIV.** switch to **0.2s/cm**; **X-POS.** control in mid-range). This check is only necessary after changing the cathode-ray tube.

If a precise marker signal is not available for checking the **Timebase time coefficients**, then an accurate sine-wave generator may be used. Its frequency tolerance should not be greater than $\pm 1\%$. The timebase accuracy of the HM203-6 is given as $\pm 3\%$, but as a rule it is considerably better than this. For the simultaneous checking of timebase linearity and accuracy at least 10 oscillations, i.e. **1 cycle every cm**, should always be displayed. For precise determination, set the peak of the first marker or cycle peak exactly behind the first vertical graticule line using the **X-POS.** control. Deviation tendencies can be noted after some of the marker or cycle peaks.

The **20** and **10ms/cm** ranges of the **TIME/DIV.** switch can be checked very precisely with line frequency (**50Hz only**). On the **20ms/cm** range a cycle will be displayed every cm, while on the **10ms/cm** range it will be every 2cm.

If a precise Time Mark Generator is used for checking, e.g. HZ62, Normal Triggering (**AT/NORM.** button depressed) and **LEVEL** control adjustment is recommended.

The following table shows which frequencies are required for the particular ranges.

Trace Alignment

0.2 s/cm – 5 Hz	0.2 ms/cm – 5 kHz
0.1 s/cm – 10 Hz	0.1 ms/cm – 10 kHz
50 ms/cm – 20 Hz	50 μ s/cm – 20 kHz
20 ms/cm – 50 Hz	20 μ s/cm – 50 kHz
10 ms/cm – 100 Hz	10 μ s/cm – 100 kHz
5 ms/cm – 200 Hz	5 μ s/cm – 200 kHz
2 ms/cm – 500 Hz	2 μ s/cm – 500 kHz
1 ms/cm – 1 kHz	1 μ s/cm – 1 MHz
0.5 ms/cm – 2 kHz	0.5 μ s/cm – 2 MHz

The CRT has an admissible angular deviation $\pm 5^\circ$ between the X deflection plane D1-D2 and the horizontal center line of the internal graticule. This deviation, due to tube production tolerances (and only important after changing the CRT), and also the influence of the earth's magnetic field, which is dependent on the instrument's North orientation, are corrected by means of the **TR** potentiometer. In general, the trace rotation range is asymmetric. It should be checked, whether the baseline can be adjusted somewhat sloping **to both sides** round about the horizontal center line of the graticule. With the HM203-6 in its closed case, an angle of rotation $\pm 0.57^\circ$ (1 mm difference in elevation per 10 cm graticule length) is sufficient for the compensation of the earth's magnetic field.

Mains/Line Voltage Checks

If a variable mains/line transformer is available, the characteristics of the HM203-6 on power voltage fluctuations of $\pm 10\%$, referred to the voltage indicated by a triangle above the fuse holder (rear panel), should be checked. Under these conditions no variations should be detected on the display in either the vertical or horizontal axis.

The **time variable control** range can also be checked. The sweep speed becomes faster by turning this variable control clockwise to its right stop. One cycle at least every **2.5 cm** should be displayed (with **X-MAG. x10** button in out position; measurement in the **50 μ s/cm** range).

When the **X-MAG. x10** button is depressed, a marker or cycle peak will be displayed every 10 cm $\pm 5\%$ (with variable control in **CAL.** position; measurement in the **5 μ s/cm** range). The tolerance is better measurable in the **50 μ s/cm** range (one cycle every 1 cm).

Holdoff time

The variation of the holdoff time during turning the **HOLD OFF** knob can not be tested without opening the instrument. However, a visual check can be made.

Without input signal, set **TIME/DIV.** and time variable control cw, use automatic triggering. At the left hand stop of the **HOLDOFF** knob, the trace should be bright. It should darken remarkably at the right hand stop of the **HOLDOFF** knob.

Component Tester

After pressing the **CT** button, a horizontal straight line has to appear immediately, when the **CT** socket is open. The length of this trace should be approx. **8 cm**. With connection of the **CT** socket to one of the ground jacks in the Y-Section, a vertical straight line with approx. 6 cm height should be displayed. The above stated measurements have some tolerances. They are dependent among other things on the mains/line voltage.

HAMEG

Oscilloscopes

Multimeters

Counter Timers

Power Supplies

Calibrators

**Signal
Generators**

**Check Point
Testers**

West Germany

HAMEG GmbH

Kelsterbacher Str. 15-19
6000 FRANKFURT am Main 71
Tel. (069) 67805-0 · Telex 413866
Telefax (069) 6780513

France

HAMEG S.a.r.l.

5-9, av. de la République
94800-VILLEJUIF
Tél. (1) 46 77 81 51 · Télex 270 705
Telefax (1) 47 26 35 44

Spain

HAMEG S.A.

Villarroel 172-174
08036 BARCELONA
Teléf. (93) 230 1597 / 230 1100
Telex 99816 · Telefax (93) 321 2201

Great Britain

HAMEG LTD

74-78 Collingdon Street
LUTON, Bedfordshire LU1 1RX
Tel. (0582) 41 31 74 · Telex 825 484
Telefax (0582) 45 64 16

United States of America

HAMEG, Inc.

88-90 Harbor Road
PORT WASHINGTON, NY 11050
Phone (516) 883-3837
Telex (023) 497-4606
Telefax (516) 883-3894

HAMEG, Inc.

Hancock Business Park
4790 Wesley Drive
ANAHEIM, CA 92807
Phone (714) 970-9575
Telefax (714) 970-0328